

SUZUKI

GS1000G/L

SUPPLEMENTARY SERVICE MANUAL

SR-8503 (英) E-03
SUPPL-2

GS1000G/L SUZUKI MOTOR CO., LTD. AUGUST, '80 PRINTED IN JAPAN SR-8503 SUPPL-2

FOREWORD

The Suzuki GS1000GT and GS1000GLT are new 1980 models and incorporate many refinements and technical changes such as shaft drive mechanism and transistorized ignition system, from the model, GS1000N. This supplementary service manual has been produced to aid Suzuki mechanics in properly maintaining and repairing these model motorcycles, which incorporate so many new and innovative changes. These technical improvements have further enhanced the comfort, handling and overall performance of these outstanding models.

This manual has been written primarily for the experienced Suzuki mechanic but will also be very useful even for the amateur, do-it-yourself mechanic. The entire manual should be thoroughly reviewed before any servicing is performed.

Please also refer to the GS1000 Service Manual for all other areas of information not covered in this publication.

IMPORTANT

All Suzuki motorcycles manufactured on or after January 1, 1978, were subject to Environmental Protection Agency emission regulations.

These regulations set specific standards for emission control, and also set new servicing requirements. This manual contains pertinent information that should be carefully studied. Other, vital emission information is also contained in the GS1000 Service Manual and should also be carefully reviewed.

Complete information concerning the EPA emission regulation and U. S. Suzuki's emission control program can be found in the U. S. SUZUKI EMISSION CONTROL PROGRAM MANUAL.

SUZUKI MOTOR CO., LTD.

*Service Department
Overseas Operations Division*

Quoting, copying or otherwise using any part of this manual without explicit authorization from Suzuki Motor Co., Ltd. is not permitted as all rights to the publication are reserved under copyright law.



CONTENTS

I GS1000GT	2
SPECIFICATIONS.....	3
SERVICE DATA	5
TORQUE TABLE	16
SPECIAL MATERIALS	19
PERIODIC MAINTENANCE	21
EMISSION CONTROL AND REGULATIONS	22
ENGINE REMOVAL AND REMOUNTING	26
SECONDARY BEBEL GEAR ASSEMBLY	30
CLUTCH	41
CRANK CASE.....	46
TRANSMISSION.....	48
LUBRICATION SYSTEM	56
SHAFT DRIVE	58
FINAL DRIVE BEVEL GEAR ASSEMBLY.....	60
FULL-TRANSISTORIZED IGNITION SYSTEM	75
CHARGING SYSTEM.....	80
FRONT FORK.....	84
FRONT MASTER CYLINDER	86
FRONT CALIPER.....	90
REAR WHEEL.....	94
REAR SWINGING ARM.....	99
WIRE AND CABLE ROUTING.....	102
WIRING DIAGRAM	104
II GS1000GLT	105
SPECIFICATIONS.....	106
SERVICE DATA	108
FUEL COCK	110
FRONT FORK.....	111
FRONT MASTER CYLINDER	112
WIRE AND CABLE ROUTING.....	113
WIRING DIAGRAM	115

I GS1000GT

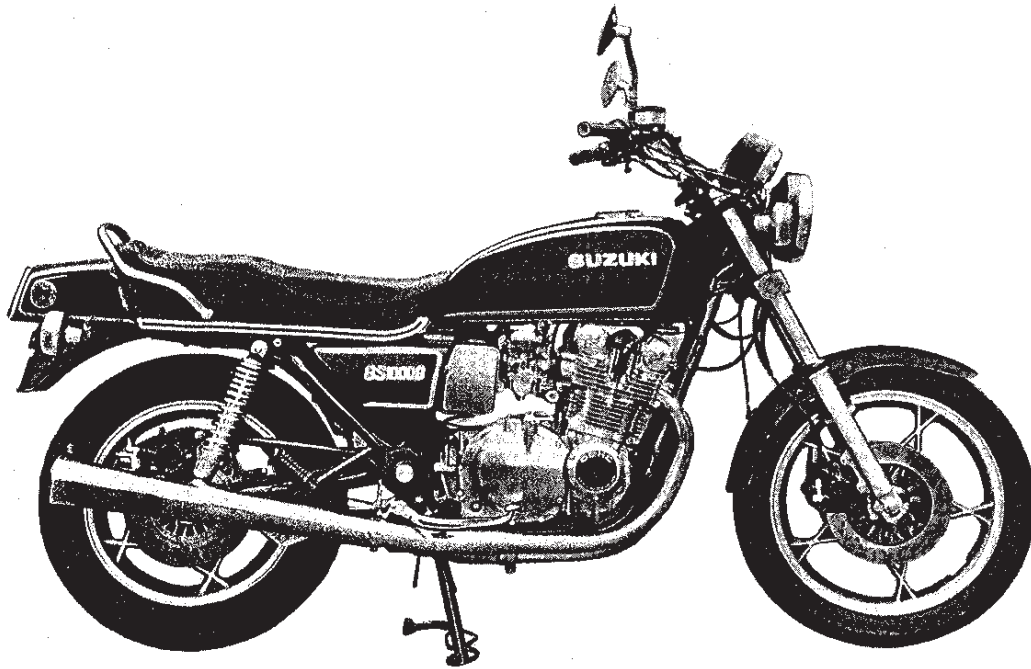

Right side

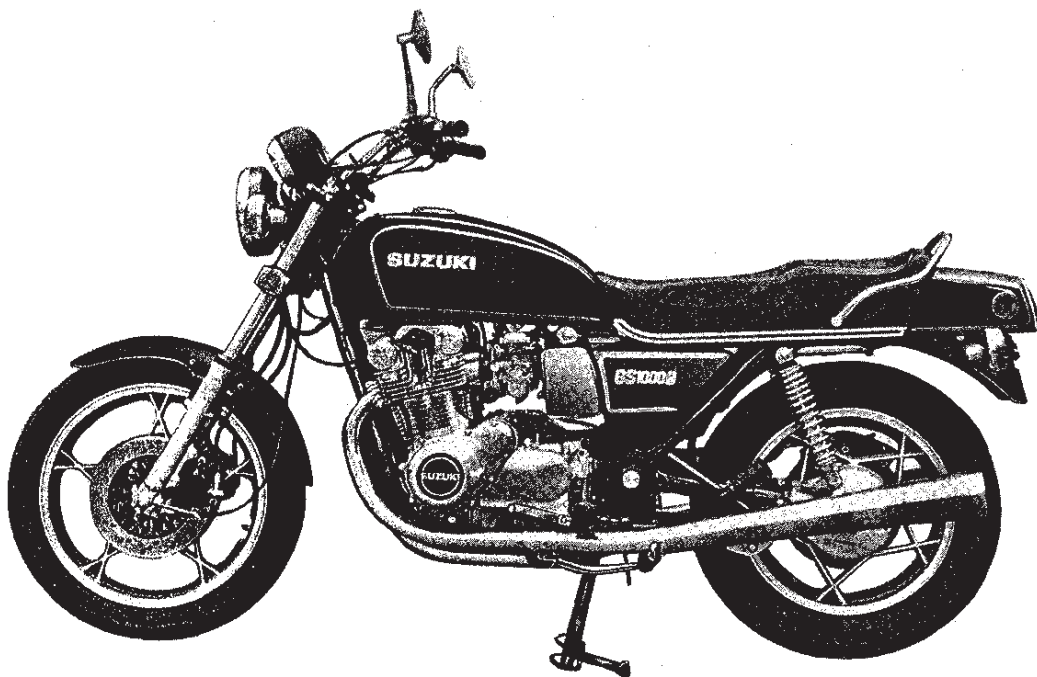

Left side

SPECIFICATIONS

DIMENSIONS AND DRY MASS

Overall length	2 230 mm (87.8 in)
Overall width	875 mm (34.4 in)
Overall height	1 175 mm (46.3 in)
Wheelbase	1 500 mm (59.1 in)
Ground clearance	150 mm (5.9 in)
Dry mass	255 kg (562 lbs)
Gross vehicle weight rating	504 kg (1 112 lbs)

ENGINE

Type	Four-stroke, air-cooled, DOHC
Number of cylinders	4
Bore	70.0 mm (2.756 in)
Stroke	64.8 mm (2.551 in)
Piston displacement	997 cm ³ (60.8 cu. in)
Compression ratio	9.2 : 1
Carburetor	MIKUNI BS34SS, four
Air cleaner	Polyurethane foam element
Starter system	Electric
Lubrication system	Wet sump

TRANSMISSION

Clutch	Wet multi-plate type
Transmission	5-speed constant mesh
Gearshift pattern	1-down, 4-up
Primary reduction	1.775 (87/49)
Gear ratios, Low	2.500 (35/14)
2nd	1.777 (32/18)
3rd	1.380 (29/21)
4th	1.125 (27/24)
Top	0.961 (25/26)

SECONDARY DRIVE

Type	Shaft drive
Secondary reduction	0.941 (16/17)
Final reduction	3.090 (34/11)

CHASSIS

Front suspension	Telescopic, pneumatic/coil spring, oil dampened
Rear suspension	Swinging arm, oil dampened, damper 4-way/spring 5-way adjustable
Steering angle	40° (right and left)
Caster	62° 30'
Trail	112 mm (4.41 in)
Turning radius	2.6 m (8.5 ft)
Front brake	Disc brake, twin
Rear brake	Disc brake
Front tire size	3.50V19 4PR
Rear tire size	4.50V17 4PR
Front tire pressure	175 kPa (1.75 kg/cm ² , 25 psi) (Normal solo riding)
Rear tire pressure	200 kPa (2.00 kg/cm ² , 28 psi) Normal solo riding)

ELECTRICAL

Ignition type	Transistorized
Ignition timing	17° B.T.D.C. below 1 500 r/min and 37° B.T.D.C. above 2 350 r/min
Spark plug	NGK B8ES or NIPPON DENSO W24ES-U
Spark plug gap	0.6 — 0.8 mm (0.024 — 0.031 in) both NGK and NIPPON DENSO
Battery	12V 50.4 kC (14Ah)/10HR
Generator	Three-phase A.C. generator
Fuse	10/10/10/10/15A

CAPACITIES

Fuel tank including reserve	22 L (5.8 US gal)
reserve	4.2 L (1.1 US gal)
Engine oil Change	3.0 L (3.2 US qt)
filter change	3.3 L (3.5 US qt)
overhaul	3.7 L (3.9 US qt)
Secondary bevel gear oil	340 — 400 ml (11.5 — 13.5 US oz)
Final bevel gear oil	280 — 330 ml (9.5 — 11.2 US oz)
Front fork air pressure	60 kPa (0.6 kg/cm ² , 8.5 psi)
Front fork oil	251 ml (8.48 US oz) in each leg

Specifications subject to change without notice.

SERVICE DATA

VALVES + GUIDES

Unit: mm (in)

Item		Standard	Limit
Valve dia.	IN.	37.9 – 38.1 (1.49 – 1.50)	—
	EX.	31.9 – 32.1 (1.25 – 1.26)	—
Valve lift	IN.	8.0 (0.31)	—
	EX.	7.5 (0.30)	—
Valve clearance or Tappet clearance (when cold)	IN/EX	0.03 – 0.08 (0.001 – 0.003)	—
Valve guide to Valve stem clearance	IN.	0.025 – 0.055 (0.0009 – 0.0022)	0.090 (0.0035)
	EX.	0.040 – 0.070 (0.0016 – 0.0028)	0.100 (0.0039)
Valve guide I.D.	IN/EX	7.000 – 7.015 (0.2756 – 0.2762)	—
Valve stem O.D.	IN.	6.960 – 6.975 (0.2740 – 0.2746)	—
	EX.	6.945 – 6.960 (0.2734 – 0.2740)	—
Valve stem runout	IN/EX	—	0.05 (0.002)
Valve head thickness	IN/EX	—	0.5 (0.02)
Valve seat width	IN/EX	1.1 – 1.3 (0.04 – 0.05)	—
Valve head radial runout	IN/EX	—	0.03 (0.001)
Valve spring free length IN/EX	INNER	—	33.9 (1.33)
	OUTER	—	41.3 (1.63)
Valve spring tension IN/EX	INNER	29.3 – 34.0 kg (64.59 – 74.96 lbs) at length 23 mm (0.91 in)	—
	OUTER	50.4 – 58.3 kg (111.11 – 128.53 lbs) at length 27 mm (1.06 in)	—

CAMSHAFT + CYLINDER + HEAD

Unit: mm (in)

Item		Standard	Limit
Cam height	IN.	36.320 – 36.360 (1.4299 – 1.4315)	36.020 (1.4181)
	EX.	35.770 – 35.810 (1.4083 – 1.4098)	35.470 (1.3965)
Camshaft journal oil clearance	IN/EX	0.037 – 0.065 (0.0015 – 0.0026)	0.150 (0.0059)
Camshaft journal holder I.D.	IN/EX	22.012 – 22.025 (0.8666 – 0.8671)	–
Camshaft journal O.D.	IN/EX	21.960 – 21.975 (0.8646 – 0.8652)	–
Camshaft runout	IN/EX	–	0.1 (0.004)
Cam chain 20 pitch length		–	157.80 (6.213)
Cam chain pin (at arrow “3”)		20th pin	–
Cylinder head distortion		–	0.2 (0.008)

PISTON+RING+CYLINDER

Unit: mm (in)

Item	Standard	Limit
Compression pressure	900 — 1 300 kPa (9 — 13 kg/cm ² , 128 — 185 psi)	700 kPa (7 kg/cm ² , 100 psi)
Compression pressure difference	—	200 kPa (2 kg/cm ² , 28 psi)
Piston to Cylinder clearance	0.050 — 0.060 (0.0020 — 0.0024)	0.120 (0.0047)
Cylinder bore	70.000 — 70.015 (2.7559 — 2.7565)	70.080 (2.7590)
Piston dia.	69.945 — 69.960 (2.7537 — 2.7543) Measure the 10 (0.39) from piston skirt end.	69.880 (2.7512)
Cylinder distortion	—	0.2 (0.008)
Piston ring free end gap	1st N Approx. 8.5 (0.33)	6.8 (0.27)
	2nd N Approx. 8.5 (0.33)	6.8 (0.27)
Piston ring end gap	1st 0.15 — 0.35 (0.006 — 0.014)	0.7 (0.03)
	2nd 0.15 — 0.35 (0.006 — 0.014)	0.7 (0.03)
Piston ring groove clearance	1st —	0.180 (0.0071)
	2nd —	0.150 (0.0059)
Piston ring groove width	1st 1.21 — 1.23 (0.047 — 0.048)	—
	2nd 1.21 — 1.23 (0.047 — 0.048)	—
	Oil 2.51 — 2.53 (0.099 — 0.100)	—
Piston ring thickness	1st 1.175 — 1.190 (0.0463 — 0.0469)	—
	2nd 1.170 — 1.190 (0.0461 — 0.0469)	—
Piston pin bore I.D.	18.002 — 18.008 (0.7087 — 0.7090)	18.030 (0.7098)
Piston pin O.D.	17.995 — 18.000 (0.7085 — 0.7087)	17.980 (0.7079)

CRANKSHAFT

Unit: mm (in)

Item	Standard	Limit
Conrod small end I.D.	18.006 – 18.014 (0.7089 – 0.7092)	18.040 (0.7102)
Conrod deflection	—	3.0 (0.12)
Conrod big end side clearance	0.10 – 0.65 (0.004 – 0.026)	1.00 (0.039)
Crankshaft runout	—	0.1 (0.004)

OIL PUMP

Unit: mm (in)

Item	Standard	Limit
Oil pump reduction ratio	1.723 (87/49 × 33/34)	—
Oil pressure (at 60°C, 140°F)	Above 10 kPa (0.1 kg/cm ² , 1.42 psi) Below 50 kPa (0.5 kg/cm ² , 7.11 psi) at 3 000 r/min.	—
Tip clearance	—	0.20 (0.008)
Outer rotor clearance	—	0.25 (0.010)
Side clearance	—	0.15 (0.006)

CLUTCH

Unit: mm (in)

Item	Standard	Limit
Clutch cable play	2 – 3 (0.08 – 0.12)	—
Drive plate thickness	2.9 – 3.1 (0.11 – 0.12)	2.6 (0.10)
Drive plate claw width	15.6 – 15.8 (0.61 – 0.62)	14.8 (0.58)
Driven plate thickness	2.0 ± 0.06 (0.08 ± 0.002)	—
Driven plate distortion	—	0.1 (0.004)
Clutch spring free length	—	38.5 (1.52)

TRANSMISSION

Unit: mm (in)

Item	Standard	Limit
Primary reduction	1.775 (87/49)	—
Secondary reduction	0.941 (16/17)	—
Final reduction	3.090 (34/11)	—
Gear ratios	Low	2.500 (35/14)
	2nd	1.777 (32/18)
	3rd	1.380 (29/21)
	4th	1.125 (27/24)
	Top	0.961 (25/26)
Shift fork to Groove clearance	0.4 – 0.6 (0.016 – 0.024)	0.8 (0.031)
Shift fork Groove width	5.45 – 5.55 (0.215 – 0.219)	—
Shift fork thickness	4.95 – 5.05 (0.195 – 0.199)	—

SHAFT DRIVE

Unit: mm (in)

Item	Standard	Limit
Secondary bevel gear backlash	0.08 – 0.13 (0.003 – 0.005)	—
Final bevel gear backlash	0.03 – 0.64 (0.001 – 0.025)	—
Secondary drive bevel gear preload	30 – 50 N·cm (3 – 5 kg·cm, 2.60 – 4.35 lb·in)	—
Secondary driven bevel gear preload	40 – 70 N·cm (4 – 7 kg·cm, 3.45 – 6.05 lb·in)	—
Final drive bevel gear preload	40 – 80 N·cm (4 – 8 kg·cm, 3.45 – 6.95 lb·in)	—

CARBURETOR

Unit: mm (in)

Item	Specification
Carburetor type	MIKUNI BS34SS
Bore size	34 (1.34)
I.D. No.	49150
Idle r/min.	1 050±100 r/min.
Fuel level	5.0±0.5 (0.20±0.02)
Float height	22.4±1.0 (0.88±0.04)
Maint jet (M. J.)	#115
Main air jet (M. A. J.)	1.7
Jet needle (J. N.)	5D50
Needle jet (N. J.)	X-E
Pilot jet (P. J.)	#40
By pass (B. P.)	0.9, 0.8, 0.8
Pilot outlet (P. O.)	0.7
Valve seat (V.S.)	2.0
Starter jet (G. S.)	45
Pilot screw (P. S.)	PRE - SET
Throttle cable play	0.5 - 1.0 (0.02 - 0.04)

ELECTRICAL

Unit: mm (in)

Item	Specification	
Ignition timing	17° B. T. D. C. Below 1 500 ± 150 r/min. and 37° B. T. D. C. Above 2 350 ± 150 r/min.	
Firing order	1, 2, 4, 3	
Spark plug	Type	NGK : B8ES N. D. : W24ES-U
	Gap	0.6 – 0.8 (0.024 – 0.031)
Spark performance	Over 8 (0.3) at 1 atm.	
Signal coil resistance	Approx.	290 – 360Ω BI-G
Ignition coil resistance	Primary	O/W – W or B/Y Approx. 3 – 5Ω
	Secondary	Plug cap – Plug cap Approx. 31 – 33 kΩ
Generator No-Load voltage	More than 80V (AC) at 5 000 r/min.	
Regulated voltage	14.0 – 15.5V at 5 000 r/min.	
Starter motor	Brush length	Limit: 6 (0.24)
	Commutator under cut	Limit: 0.2 (0.008)
Starter relay resistance	Approx.	3 – 4Ω
Battery	Type designation	YB14L – A2
	Capacity	12V 50.4kC (14Ah)/10HR
	Standard electrolyte S. G.	1.28 at 20°C (68°F)
Fuse size	Headlight	10A
	Turn signal	10A
	Ignition	10A
	Main	15A
	Output terminal	10A

BRAKE + WHEEL

Unit: mm (in)

Item		Standard	Limit
Rear brake pedal height		20 (0.8)	—
Brake disc thickness	Front	5.0 ± 0.2 (0.2 ± 0.008)	4.5 (0.18)
	Rear	6.7 ± 0.2 (0.26 ± 0.008)	6.0 (0.24)
Brake disc runout		—	0.30 (0.012)
Master cylinder cylinder bore	Front	15.870 — 15.913 (0.6248 — 0.6265)	—
	Rear	14.000 — 14.043 (0.5512 — 0.5529)	—
Master cylinder piston dia.	Front	15.827 — 15.854 (0.6231 — 0.6242)	—
	Rear	13.957 — 13.984 (0.5495 — 0.5506)	—
Brake caliper cylinder bore	Front	38.180 — 38.256 (1.5031 — 1.5061)	—
	Rear	38.180 — 38.256 (1.5031 — 1.5061)	—
Brake caliper piston dia.	Front	38.098 — 38.148 (1.4999 — 1.5019)	—
	Rear	38.098 — 38.148 (1.4999 — 1.5019)	—
Wheel rim runout	Axial	—	2.0 (0.08)
	Radial	—	2.0 (0.08)
Wheel axle runout	Front	—	0.25 (0.010)
	Rear	—	0.25 (0.010)
Tire size	Front	3.50V19 4PR	—
	Rear	4.50V17 4PR	—
Tire tread depth	Front	—	1.6 (0.06)
	Rear	—	2.0 (0.08)

SUSPENSION

Unit: mm (in)

Item	Standard	Limit
Front fork stroke	160 (6.3)	—
Front fork spring free length	—	416 (16.4)
Front fork oil level	140 (5.5)	—
Front fork air pressure	60 kPa (0.6 kg/cm ² , 8.5 psi)	—
Rear wheel travel	100 (3.9)	—

FUEL+OIL+CAPACITY

Unit: mm (in)

Item	Specification
Fuel type	Use only unleaded or low-lead type gasoline of at least 85 – 95 pump octance ($\frac{R+M}{2}$ method) or 89 octance or higher rated by the Research method.
Fuel tank including reserve	22 L (5.8 US gal)
reserve	4.2 L (1.1 US gal)
Engine oil type	SAE 10W/40
Engine oil capacity	Change 3 000 ml (3.2 US qt)
	Filter change 3 300 ml (3.5 US qt)
	Overhaul 3 700 ml (3.9 US qt)
Front fork oil type	SAE 10W/20
Front fork oil capacity (each leg)	251 ml (8.48 US oz)
Bevel gear oil type	Hypoid Gear oil SAE 90, API grade GL-5
Bevel gear oil capacity	Secondary 340 – 400 ml (11.5 – 13.5 US oz)
	Final 280 – 330 ml (9.5 – 11.2 US oz)
Brake fluid type	DOT3 or DOT4

TIRE PRESSURE

Cold Inflation Tire Pressure	Normal Riding						Continuous High Speed Riding					
	Solo Riding			Dual Riding			Solo Riding			Dual Riding		
	kPa	kg/cm ²	psi	kPa	kg/cm ²	psi	kPa	kg/cm ²	psi	kPa	kg/cm ²	psi
Front	175	1.75	25	200	2.00	28	200	2.00	28	225	2.25	32
Rear	200	2.00	28	250	2.50	36	250	2.50	36	280	2.80	40

WATTAGE

Unit: W(cp)

Item		Specification
Headlight	HI	60
	LO	55
Tail/Brake light		8/23 (3/32)
Turn signal light		23 (32)
Speedometer light		3.4
Tachometer light		3.4
Turn signal indicator light		3.4
High beam indicator light		3.4
Neutral indicator light		3.4
Oil pressure indicator light		3.4
License light		8 (4)

TORQUE TABLE

ENGINE

Item	N·m	kg·m	lb·ft
Camshaft holder bolt	8 – 12	0.8 – 1.2	6.0 – 8.5
Cylinder head bolt	9 – 14	0.9 – 1.4	6.5 – 10.0
Cylinder head nut	35 – 40	3.5 – 4.0	25.5 – 29.0
Cylinder head cover bolt	6 – 10	0.6 – 1.0	4.5 – 7.0
Crankcase bolt (6 mm)	6 – 10	0.6 – 1.0	4.5 – 7.0
Crankcase bolt (8 mm)	13 – 23	1.3 – 2.3	9.5 – 16.5
Starter motor bolt	4 – 7	0.4 – 0.7	3.0 – 5.0
Oil pan bolt	6 – 10	0.6 – 1.0	4.5 – 7.0
Engine mounting bolt (10 mm)	35	3.5	25.5
Engine mounting bolt (12 mm)	45 – 70	4.5 – 7.0	32.5 – 50.5
Starter clutch bolt	15 – 20	1.5 – 2.0	11.0 – 14.5
Camshaft sprocket bolt	6 – 10	0.6 – 1.0	4.5 – 7.0
Cam chain guide bolt No. 4	4 – 7	0.4 – 0.7	3.0 – 5.0
Cam chain tensioner bolt	9 – 14	0.9 – 1.4	6.5 – 10.0
Cam chain tensioner adjuster bolt	4 – 7	0.4 – 0.7	3.0 – 5.0
Exhaust pipe bolt	9 – 14	0.9 – 1.4	6.5 – 10.0
Muffler bolt	18 – 28	1.8 – 2.8	13.0 – 20.0
Pressure switch housing bolt	6 – 9	0.6 – 0.9	4.5 – 6.0
Clutch spring bolt	8 – 12	0.8 – 1.2	6.0 – 8.5
Clutch sleeve hub nut	50 – 70	5.0 – 7.0	36.0 – 50.5
Clutch release arm bolt	6 – 10	0.6 – 1.0	4.5 – 7.0
Gear shifting cam stopper spring holder bolt	18 – 28	1.8 – 2.8	13.0 – 20.0
Gear shift arm stopper	15 – 22	1.5 – 2.2	11.0 – 16.0
Gear shift lever bolt	13 – 23	1.3 – 2.3	9.5 – 16.5
Generator rotor bolt	90 – 100	9.0 – 10.0	65.0 – 72.5
Secondary drive gear nut	120 – 150	12.0 – 15.0	87.0 – 108.5
Secondary driven gear nut	90 – 110	9.0 – 11.0	65.0 – 79.5
Secondary drive housing bolt	20 – 26	2.0 – 2.6	14.5 – 19.0
Secondary driven housing bolt	20 – 26	2.0 – 2.6	14.5 – 19.0

TORQUE TABLE

ENGINE

Item	N·m	kg·m	lb·ft
Camshaft holder bolt	8 — 12	0.8 — 1.2	6.0 — 8.5
Cylinder head bolt	9 — 14	0.9 — 1.4	6.5 — 10.0
Cylinder head nut	35 — 40	3.5 — 4.0	25.5 — 29.0
Cylinder head cover bolt	6 — 10	0.6 — 1.0	4.5 — 7.0
Crankcase bolt (6 mm)	6 — 10	0.6 — 1.0	4.5 — 7.0
Crankcase bolt (8 mm)	13 — 23	1.3 — 2.3	9.5 — 16.5
Starter motor bolt	4 — 7	0.4 — 0.7	3.0 — 5.0
Oil pan bolt	6 — 10	0.6 — 1.0	4.5 — 7.0
Engine mounting bolt (10 mm)	35	3.5	25.5
Engine mounting bolt (12 mm)	45 — 70	4.5 — 7.0	32.5 — 50.5
Starter clutch bolt	15 — 20	1.5 — 2.0	11.0 — 14.5
Camshaft sprocket bolt	6 — 10	0.6 — 1.0	4.5 — 7.0
Cam chain guide bolt No. 4	4 — 7	0.4 — 0.7	3.0 — 5.0
Cam chain tensioner bolt	9 — 14	0.9 — 1.4	6.5 — 10.0
Cam chain tensioner adjuster bolt	4 — 7	0.4 — 0.7	3.0 — 5.0
Exhaust pipe bolt	9 — 14	0.9 — 1.4	6.5 — 10.0
Muffler bolt	18 — 28	1.8 — 2.8	13.0 — 20.0
Pressure switch housing bolt	6 — 9	0.6 — 0.9	4.5 — 6.0
Clutch spring bolt	8 — 12	0.8 — 1.2	6.0 — 8.5
Clutch sleeve hub nut	50 — 70	5.0 — 7.0	36.0 — 50.5
Clutch release arm bolt	6 — 10	0.6 — 1.0	4.5 — 7.0
Gear shifting cam stopper spring holder bolt	18 — 28	1.8 — 2.8	13.0 — 20.0
Gear shift arm stopper	15 — 22	1.5 — 2.2	11.0 — 16.0
Gear shift lever bolt	13 — 23	1.3 — 2.3	9.5 — 16.5
Generator rotor bolt	90 — 100	9.0 — 10.0	65.0 — 72.5
Secondary drive gear nut	120 — 150	12.0 — 15.0	87.0 — 108.5
Secondary driven gear nut	90 — 110	9.0 — 11.0	65.0 — 79.5
Secondary drive housing bolt	20 — 26	2.0 — 2.6	14.5 — 19.0
Secondary driven housing bolt	20 — 26	2.0 — 2.6	14.5 — 19.0

TIRE PRESSURE

Cold Inflation Tire Pressure	Normal Riding						Continuous High Speed Riding					
	Solo Riding			Dual Riding			Solo Riding			Dual Riding		
	kPa	kg/cm ²	psi	kPa	kg/cm ²	psi	kPa	kg/cm ²	psi	kPa	kg/cm ²	psi
Front	175	1.75	25	200	2.00	28	200	2.00	28	225	2.25	32
Rear	200	2.00	28	250	2.50	36	250	2.50	36	280	2.80	40

WATTAGE

Unit: W(cp)

Item		Specification
Headlight	HI	60
	LO	55
Tail/Brake light		8/23 (3/32)
Turn signal light		23 (32)
Speedometer light		3.4
Tachometer light		3.4
Turn signal indicator light		3.4
High beam indicator light		3.4
Neutral indicator light		3.4
Oil pressure indicator light		3.4
License light		8 (4)

For other bolts and nuts not listed above, refer to this chart:

TIGHTENING TORQUE

Thread Diameter (mm)	Conventional or "4" Marked Bolt			"7" Marked Bolt		
	N•m	kg•m	lb•ft	N•m	kg•m	lb•ft
4	1.0 – 2.0	0.1 – 0.2	0.7 – 1.5	1.5 – 3.0	0.15 – 0.3	1.0 – 2.0
5	2.0 – 4.0	0.2 – 0.4	1.5 – 3.0	3.0 – 6.0	0.3 – 0.6	2.0 – 4.5
6	4.0 – 7.0	0.4 – 0.7	3.0 – 5.0	8.0 – 12.0	0.8 – 1.2	6.0 – 8.5
8	10.0 – 16.0	1.0 – 1.6	7.0 – 11.5	18.0 – 28.0	1.8 – 2.8	13.0 – 20.0
10	22.0 – 35.0	2.2 – 3.5	16.0 – 25.5	40.0 – 60.0	4.0 – 6.0	29.0 – 43.5
12	35.0 – 55.0	3.5 – 5.5	25.5 – 40.0	70.0 – 100.0	7.0 – 10.0	50.5 – 72.5
14	50.0 – 80.0	5.0 – 8.0	36.0 – 58.0	110.0 – 160.0	11.0 – 16.0	79.5 – 115.5
16	80.0 – 130.0	8.0 – 13.0	58.0 – 94.0	170.0 – 250.0	17.0 – 25.0	123.0 – 181.0
18	130.0 – 190.0	13.0 – 19.0	94.0 – 137.5	200.0 – 280.0	20.0 – 28.0	144.5 – 202.5

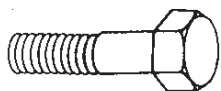

Conventional Bolt

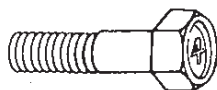

"4" Marked Bolt

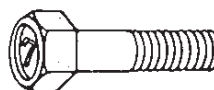





"7" Marked Bolt



CHASSIS

Item	N·m	kg·m	lb·ft
Handlebar clamp bolt	12 – 20	1.2 – 2.0	8.5 – 14.5
Steering stem upper clamp bolt	15 – 25	1.5 – 2.5	11.0 – 18.0
Front fork upper bracket bolt (R, L)	20 – 30	2.0 – 3.0	14.5 – 21.5
Front fork lower bracket bolt (R, L)	15 – 25	1.5 – 2.5	11.0 – 18.0
Steering stem head nut	35 – 50	3.5 – 5.0	25.5 – 36.0
Front fork axle holder nut	15 – 25	1.5 – 2.5	11.0 – 18.0
Front axle shaft nut	36 – 52	3.6 – 5.2	26.0 – 37.5
Swining arm pivot bolt	3.5 – 4.5	0.35 – 0.45	2.5 – 3.0
Swining arm pivot nut	110 – 130	11.0 – 13.0	79.5 – 94.0
Rear torque link nut	20 – 30	2.0 – 3.0	14.5 – 21.5
Rear axle nut	50 – 80	5.0 – 8.0	36.0 – 58.0
Rear shock absorber nut	20 – 30	2.0 – 3.0	14.5 – 21.5
Footrest bolt	27 – 43	2.7 – 4.3	19.5 – 31.0
Front brake caliper mounting bolt	25 – 40	2.5 – 4.0	18.0 – 29.0
Front and rear brake disc plate bolt	15 – 25	1.5 – 2.5	11.0 – 18.0
Front brake caliper axle bolt	15 – 20	1.5 – 2.0	11.0 – 14.5
Front brake master cylinder mounting bolt	5 – 8	0.5 – 0.8	3.5 – 6.0
Front and rear brake hose union bolt	13 – 18	1.3 – 1.8	9.5 – 13.0
Front and rear brake oil bleeder bolt	6 – 9	0.6 – 0.9	4.5 – 6.5
Rear brake caliper mounting bolt	20 – 30	2.0 – 3.0	14.5 – 21.5
Rear brake caliper axle bolt	25 – 35	2.5 – 3.5	18.0 – 25.5
Rear brake master cylinder mounting bolt	15 – 25	1.5 – 2.5	11.0 – 18.0
Final drive gear nut	90 – 110	9.0 – 11.0	65.0 – 79.5
Final drive gear housing nut	35 – 45	3.5 – 4.5	25.5 – 32.5
Final bevel gear bearing holder screw	8 – 10	0.8 – 1.0	6.0 – 7.0
Propeller shaft bolt	25 – 30	2.5 – 3.0	18.0 – 21.5
Final gear bearing case bolt	20 – 26	2.0 – 2.6	14.5 – 19.0
Final gear case shock mount stud bolt	90 – 110	9.0 – 11.0	65.0 – 79.5
Final case oil filler plug	20 – 30	2.0 – 3.0	14.5 – 21.5
Final case oil drain plug	20 – 30	2.0 – 3.0	14.5 – 21.5

SPECIAL MATERIALS

The materials listed below are needed for maintenance work on the GS1000G, and should be kept on hand for ready use. They supplement such standard materials as cleaning fluids, lubricants, emery cloth and the like. How to use them and where to use them are described in the text of this manual.

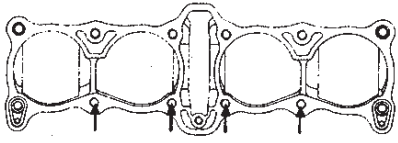
Material	Part
<p>①</p>  <p>99000-32040 THREAD LOCK CEMENT</p>	<ul style="list-style-type: none"> * Oil filter cover nut..... 3 pcs * Camshaft end cap screw 8 pcs * Front fork allen bolt 2 pcs * Carburetor adjuster bracket screw 2 pcs * Carburetor plate screw 8 pcs * Carburetor starter shaft screw..... 4 pcs
<p>②</p>  <p>99104-32050 THREAD LOCK "1363C"</p>	<ul style="list-style-type: none"> * Gearshift cam guide screw..... 2 pcs * Gearshift pawl screw..... 2 pcs * Gearshift arm stopper 1 pc * Counter shaft B/G retainer screw..... 3 pcs * Drive shaft plate screw..... 4 pcs * Generator startor screw..... 3 pcs * Generator lead wire guide screw..... 3 pcs * Engine oil pump screw 4 pcs * Oil gallery plate screw 3 pcs * Secondary drive bevel gear assy set bolt 4 pcs * Secondary driven bevel gear assy set bolt..... 4 pcs * Final bevel gear bearing holder screw 3 pcs * Final bearing case bolt 10 pcs
<p>③</p>  <p>99104-32020 THREAD LOCK SUPER "1361A"</p>	<ul style="list-style-type: none"> * Cam sprocket bolt 4 pcs * Thread portion of secondary driven gear 1 pc * Thread portion of Final drive gear..... 1 pc * Propeller shaft joint bolt 4 pcs * Starter clutch allen bolt 3 pcs * Cam chain guide bolt..... 3 pcs * Gearshift stopper 1 pc
<p>④</p>  <p>99104-32090 THREAD LOCK SUPER "1332B"</p>	<ul style="list-style-type: none"> * Generator rotor bolt..... 1 pc
<p>⑤</p>  <p>99104-32030 SUZUKI THREAD LOCK SUPER "1363A"</p>	<ul style="list-style-type: none"> * Driveshaft spacer 1 pc * Final gear case shock mount stud bolt..... 1 pc * Final gear case stud bolt 3 pcs

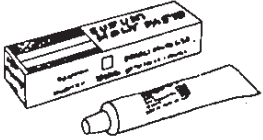
Material	Part
<p>⑥</p>  <p>99104-31100 SUZUKI BOND No. 1201</p>	<ul style="list-style-type: none"> * Mating surfaces of upper and lower crank case. * Final gear case * Joint portion of rear swinging arm and final gear case. * Cylinder stud bolt 4 pcs (Apply a small quantity to the threads of cylinder stud bolts.) <p style="text-align: center;">Front</p>  <p style="text-align: center;">Rear</p>
<p>⑦</p>  <p>99000-25100 SUZUKI SILICONE GREASE</p>	<ul style="list-style-type: none"> * Apply to caliper axle shaft
<p>⑧</p>  <p>99000-25140 SUZUKI MOLY PASTE</p>	<ul style="list-style-type: none"> * Valve stem * Cam shaft * Chain tensioner adjuster shaft * Counter shaft washer * Outer counter shaft * Input cam dog

USE OF GENUINE SUZUKI PARTS

To replace any part of the machine, use a genuine SUZUKI replacement part. Imitation parts or parts supplied from any other source than SUZUKI, if used to replace SUZUKI parts, will reduce the machine's performance and, even worse, could induce costly mechanical trouble.

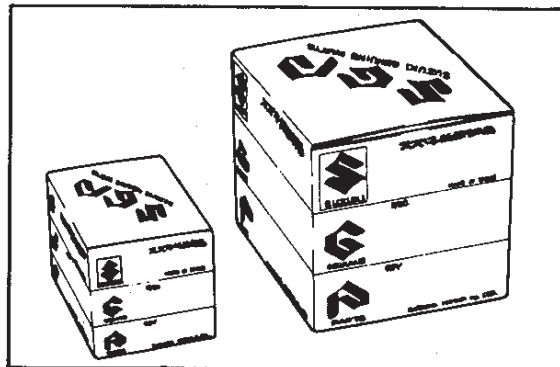

PERIODIC MAINTENANCE

IMPORTANT: The periodic maintenance intervals and service requirements have been established in accordance with EPA regulations. Following these instructions will ensure that the motorcycle will not exceed emission standards and it will also enhance the reliability and performance of the motorcycle.

NOTE:

More frequent servicing may be performed on motorcycles that are used under extreme service conditions, however, it is not necessary to ensure emission level compliance.

The chart below lists the recommended intervals for all the required periodic service work necessary to keep the motorcycle operating at peak performance and to maintain proper emission levels. Mileages are expressed in terms of kilometers, miles and time for your convenience.

PERIODIC MAINTENANCE SCHEDULE

INTERVAL: This interval should be judged by odometer reading or months whichever comes first	Mile	600	4000	7500	11000	15000
	km	1000	6000	12000	18000	24000
	Month	2	12	24	36	48
Battery (specific gravity of electrolyte)		—	I	I	I	I
Cylinder head nuts and exhaust pipe bolts		T	T	T	T	T
Air cleaner element		—	C	C	C	C
Tappet clearance		I	I	I	I	I
Spark plugs		—	C	R	C	R
Fuel line		Replace every two years				
Engine oil and oil filter		R	R	R	R	R
Carburetor idle rpm		I	I	I	I	I
Clutch		I	I	I	I	I
Secondary and Final Gear oil		Change oil at initial 600 miles (1 000 km) and thereafter every 7 500 miles (12 000 km).				
Brake hoses		Replace every two years				
Brakes		I	I	I	I	I
Tires		I	I	I	I	I
Steering stem		I	I	I	I	I
Chassis bolts and nuts		T	T	T	T	T
Front fork		—	—	I	—	I
		Check air pressure every 6 months				

NOTE: T = Tighten, I = Inspect, R = Replace, C = Clean

EMISSION CONTROL AND REGULATIONS

EMISSION REGULATIONS

On February 4, 1977, Federal Emission Regulations for motorcycles that may be licensable took effect. The regulations provided for a gradual, multi-step application of stricter emission limits beginning with all effected motorcycles manufactured after January 1, 1978, culminating with the present 1980 emission level restrictions. For the 1980 and succeeding years one set of emission limits will be in effect. They are as follows:

1980 EMISSION LIMITS

CATEGORIES	HYDROCARBONS (HC)	CARBON MONOXIDE
All motorcycles 50 cc — Larger	5.0 Grams/Kilometer (8.0 Grams/Mile)	12 Grams/Kilometer (19.3 Grams/Mile)

Emission-controlled motorcycles, which are subject to the emission regulations are those motorcycles which are equipped with a headlight, taillight, stop light and which have an engine displacement larger than 50 cc.

Suzuki Motor Company performed all the necessary testing and certification of emission-controlled models in strict compliance with the E.P.A. testing regulations. Suzuki motorcycle dealers are not required to either test or certify emission levels on any motorcycles as Suzuki Motor Company is legally responsible for the entire certification procedure.

E.P.A. regulations also provide fines for individuals who alter, render inoperative or improperly service emission-controlled motorcycles ranging up to \$10,000.00 per motorcycle. It is essential that the individual servicing this emission-controlled motorcycle review thoroughly all the service procedures presented in this manual.

Under no circumstances should the recommended service procedures be deviated from nor adjustments made which are not in accordance with the factory specifications or service procedures.

EMISSION CONTROL CARBURETOR COMPONENTS

GS1000G motorcycles are equipped with precision, manufactured carburetors for emission level control. These carburetors require special mixture control components and other precision adjustments to function properly.

There are several carburetor mixture control components in each carburetor assembly. Three (3) of these components are machined to much closer tolerances than standard machined carburetor jets. These three (3) particular jets — MAIN JET, NEEDLE JET, PILOT JET — must not be replaced by standard jets. To aid in identifying these three (3) jets a different design of letter and number are used. If replacement of these close tolerance jets becomes necessary, be sure to replace them with the same type close tolerance jets marked as in the examples shown below.

The jet needle is also of special manufacture. Only one clip position is provided on the jet needle. If replacement becomes necessary the jet needle may only be replaced with an equivalent performing replacement component. Suzuki recommends that Genuine Suzuki Parts be utilized whenever possible for the best possible performance and durability.

Conventional Figures Used on Standard Tolerance Jet Components	1 2 3 4 5 6 7 8 9 0
Emission Type Figures Used On Close Tolerance Jet Components	1 2 3 4 5 6 7 8 9 0

The carburetor specification for the emission-controlled GS1000G are as follows.

Carburetor I.D. No.	Main Jet	Needle Jet	Jet Needle	Pilot Jet	Pilot Screw
49150	#115	X-6	5D50	#40	PRE-SET DO NOT ADJUST

The pilot screw is pre-set by the factory utilizing specialized testing and adjusting procedures. The pilot screw is not adjustable as the idle circuit is "sealed" after factory adjustment. Adjusting, interfering with, improper replacement, or resetting of any of the carburetor components may adversely affect carburetor performance and cause the motorcycle to exceed the exhaust emission level limits. If persons, who are unaware of these special carburetor servicing requirements tamper with the carburetors the Suzuki dealer should restore the carburetors to their original condition or if unable to effect repairs, contact the distributors representative for further technical information and assistance.

GENERAL EMISSION INFORMATION

There are three different types of regulated exhaust emissions. They are:

- Hydrocarbons (HC)
- Carbon Monoxide (CO)
- Oxides of Nitrogen (NOx)

Automobiles must meet specific emission standards for all three of these pollutants. Motorcycles must only meet the requirements for the following:

- Hydrocarbons (HC)
- Carbon Monoxide (CO)

HC exhaust emissions are basically unburned fuel vapors which have passed through the engine and escaped the combustion process.

CO exhaust emissions are formed during an incomplete combustion cycle as a result of a rich air/fuel mixture. The only way that CO can be produced is by the combustion cycle.

Total NOx emissions from all motorcycles is considered negligible. The EPA states that total NOx emission from motorcycles by 1990 will only amount to approximately 0.5%. NOx is formed during the combustion process at high combustion chamber temperatures.

Carbon Monoxide

Carbon monoxide is a product of an incomplete combustion cycle. CO is measured in grams per mile or kilometer and also in percentage (%).

The most common cause of CO is rich carburetion. As the mixture is richened excessively, the CO amount increases proportionately. Engine oil is also a hydrocarbon, so engine problems which lead to oil burning increase carbon monoxide.

Carburetion Malfunction

1. Air Cleaner — Dirty or over oiled.
2. Idle Mixture — Adjusted incorrectly.
3. Idle Speed — Too high or low.
4. Fuel Level — Sticking float, leaking needle, incorrect setting.
5. Choke — Leaking or linkage sticking.
6. Synchronization — Improper balance on multi cylinders.

ENGINE MALFUNCTIONS

1. Valve Seals — Leaking or torn.
2. Valve Guide — Worn and leaking excess oil.
3. Gaskets — Leaking oil into combustion chamber.

Hydrocarbons

Hydrocarbons are unburnt gasoline vapors and can be measured in two different ways. The first is to measure the weight of the pollutants over a specific distance such as grams per mile or grams per kilometer. The second method is to measure the concentration of HC in the exhaust gas in parts per million (PPM).

The most common cause of high HC emissions are ignition system problems. If the ignition system fails to ignite the fuel mixture properly, then raw gasoline vapors will pass through the engine into the exhaust system. Listed are the most common ignition problems which occur and which can affect HC emission output.

Ignition System Malfunctions

1. Spark Plugs — Fouled, dirty, improper type or improperly gapped.
2. Ignition timing — Advanced or Retarded.
3. Timing Advance — Too fast or too slow an advance rate.
4. Battery — Low charge or faulty.

Carburetion can also lead to high HC emissions if the mixture is either excessively rich or excessively lean.

Mixture-related Malfunctions

1. Air Cleaner — Dirty, over oiled or torn.
2. Jets — Clogged, restricted or incorrect size.
3. Float Level — Level too low (lean) or too high (rich).
4. Choke — Leaking choke plunger or sticking linkage.
5. Air Leaks — Intake manifolds, engine gaskets and other sealing surfaces.
6. Synchronization — Unbalanced on multi-cylinder machines.
7. Exhaust System — Restricted flow or improper exhaust system.

Engine wear or damage can also cause high HC emissions.

1. Rings — Low compression, leakage into crankcase.
2. Valves — Improper adjustment, bent stem or burnt.
3. Gaskets — Leaking, loss of compression.
4. Crank Seals — Leaking.
5. Oil Consumption — Worn valve guides, worn rings, clogged crankcase breather.
6. Oil — Improper engine oil.

ENGINE REMOVAL AND REMOUNTING

REMOVAL

- Place an oil pan under the engine and remove the engine oil drain plug and oil filter cap to drain off engine oil.

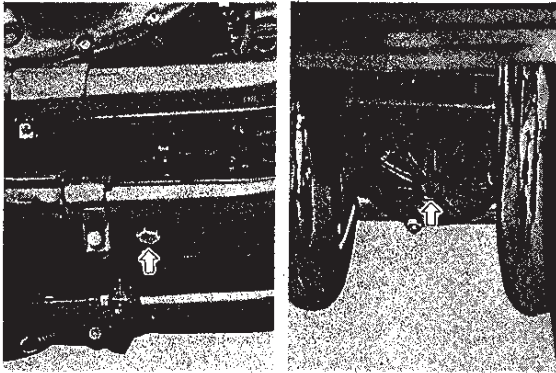

- Place an oil pan under the secondary drive drain plug and remove the gear shifting lever and secondary drive unit cover. Next, remove the drain plug and drain off the secondary gear oil.

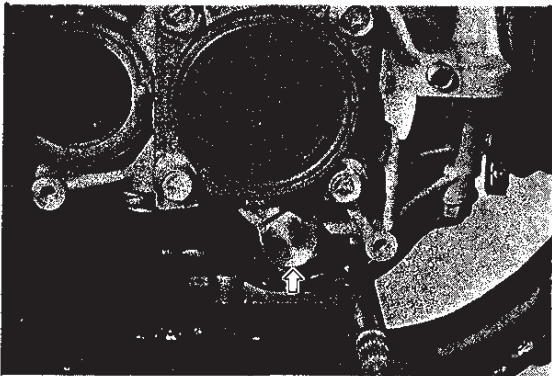
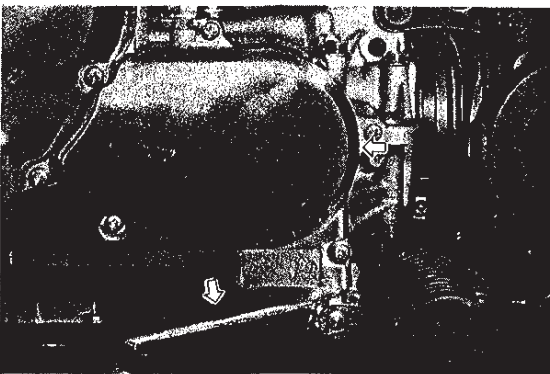

- Set the fuel cock lever to the "ON" or "RES" position and shift the fuel pipe clip sideways to remove the two hoses from the fuel cock.
- Remove the lead wire of fuel meter sensor located at the lower left side of the fuel tank.

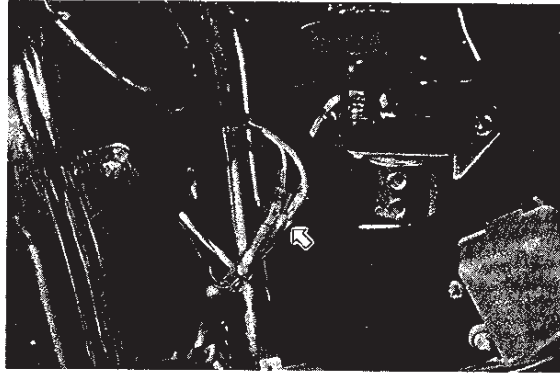

- Open the seat and remove the bolt at the rear of the fuel tank. Remove the tank rearwards.

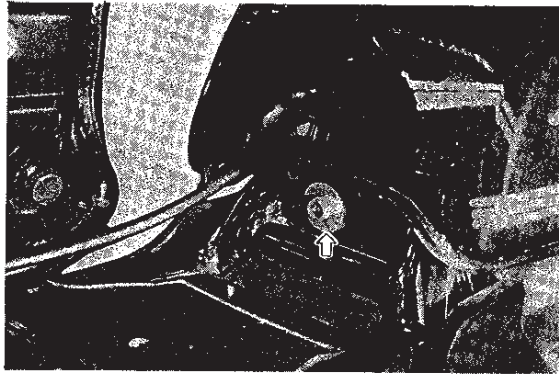

- Move the intake pipe clamp off position and disconnect the intake pipe from the breather cover.

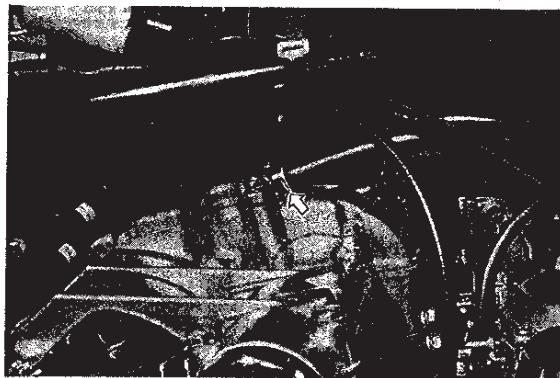

- Remove the left and right frame side covers.
- First of all, remove the battery ⊖ terminal, then remove ⊕ terminal.
- Remove the connectors from various lead wires.
 - AC generator lead wire.
 - Starter relay ⊖ terminal.
 - Signal generator lead wire.
 - Gear position lead wire.
 - Oil pressure gauge lead wire.
 - Plug cords.
- Remove the right and left bolts ① securing the air cleaner body to the frame.
- Loosen the four air cleaner clamp screws ②, move the air cleaner a little rearward, and remove it from the carburetor. Next, remove the air cleaner to the right.

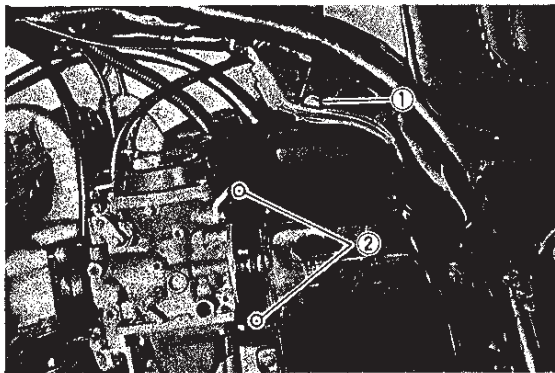

- Loosen the throttle cable lock nut ③, and remove both inner and outer cables from the carburetor lever.
- Loosen the starter cable mounting bolt ④, and remove both inner and outer cables from the carburetor.

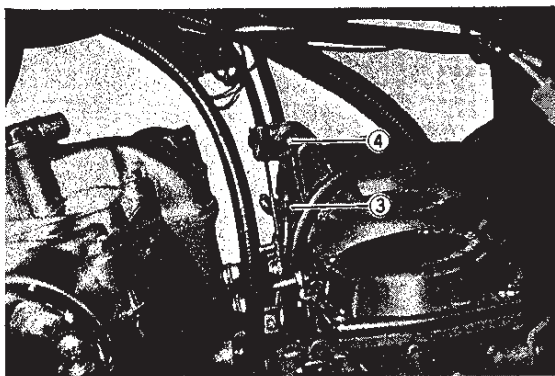

- Loosen the clamps for the intake manifolds and remove the carburetors by pulling toward the rear.
- Loosen the clamp screw securing the propeller shaft boot, and move the propeller shaft boot rearward.

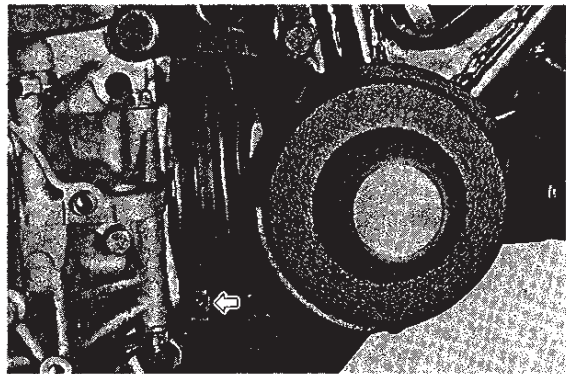

- Remove the four bolts securing the universal joint flange and propeller shaft.

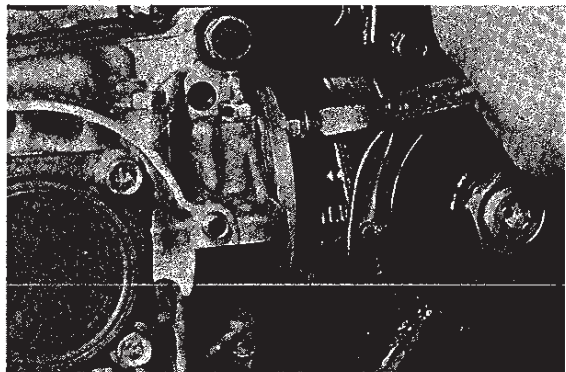

- Remove the brake pedal mounting bolt. Next, move the pedal return spring off the peg, and remove the pedal.
- Remove the right footrest.

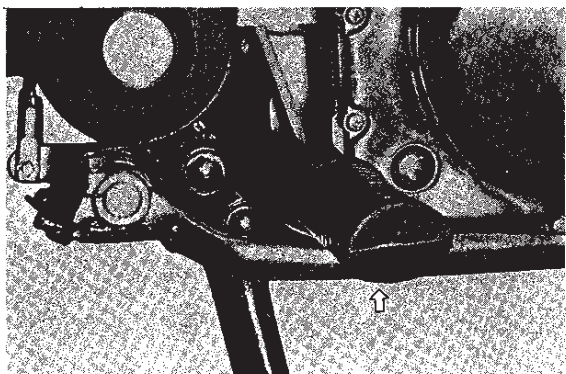

- Remove the exhaust bolts, remove the right and left muffler mounting bolts, and loosen the exhaust coupler bolt and remove the mufflers.

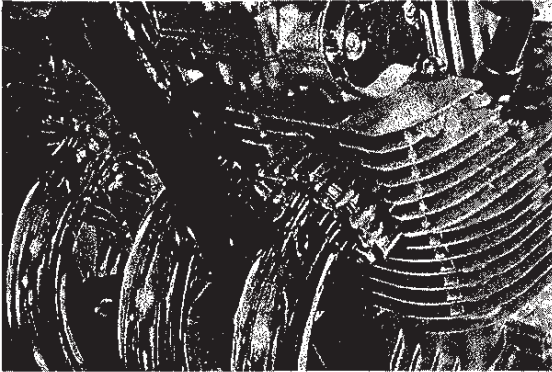

- Remove the lead wires and mounting bolts of the horn mounting brackets, then remove the assembly.

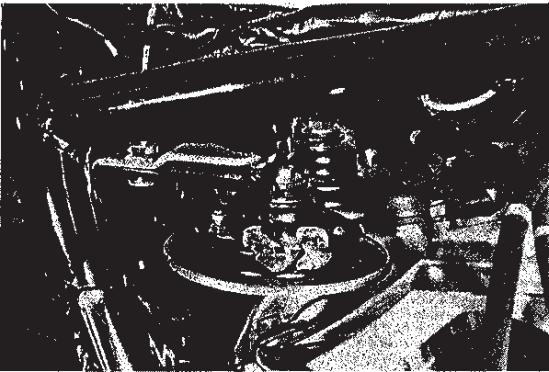

- Fully loosen the clutch cable lock nut and adjuster bolts on the engine side. Then loosen the clutch release arm bolt and remove the clutch release arm by lifting it upward.

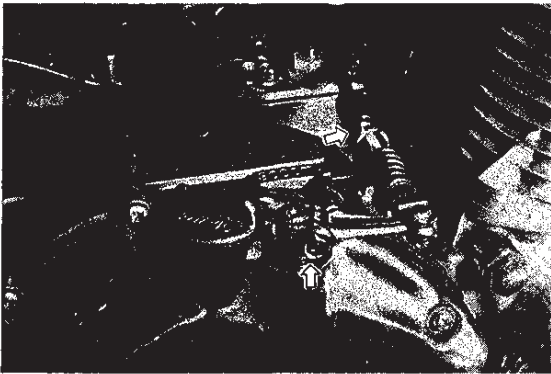

- Remove all of the bolt — on engine mounting brackets.

Right side

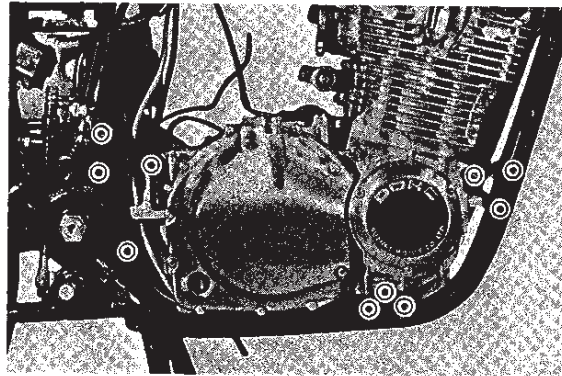

Left side

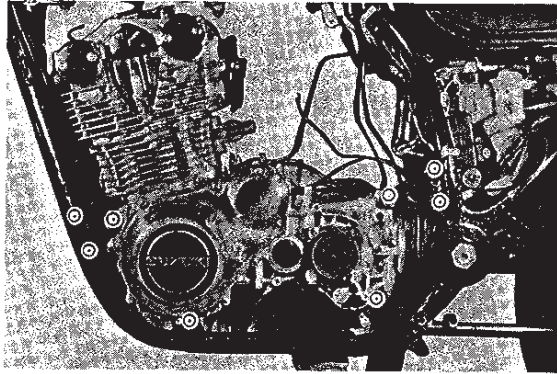

- Support the weight of engine with a jack or stand and remove the engine mounting bolts and nuts.

- Lift the engine up and out the right side of the frame: be careful not to scar the upper or lower frame tubes.



REMountING

For remounting, reverse the order of engine removal.

NOTE:

When remounting the engine assembly, be carefull not to damage the drive shaft rubber boot.

- Temporarily fasten the engine mounting bracket before inserting the engine mounting bolts.
- After inserting the engine mounting bolts, tighten engine mounting bracket bolts and engine mounting bolts. Insert all three long bolts from the left side.

Tightening torque for engine mounting bolts	
10 mm Dia.	35 N·m 3.5 kg·m 25.5 lb·ft
12 mm Dia.	45 – 70 N·m 4.5 – 7.0 kg·m 32.5 – 50.5 lb·ft

- Secure the universal joint flange and propeller shaft with four bolts at four places. Be sure to apply SUZUKI LOCK SUPER “1361A” to the bolts.

Bolt tightening torque:	25 – 30 N·m 2.5 – 3.0 kg·m 18.0 – 21.5 lb·ft
-------------------------	--

- Install the propeller shaft boot with the clamp (front side) and spring (rear side).
- Firmly secure the carburetor with the clamps. If the carburetor is not firmly scured, gas leakage, incorrect air-fuel ratio and unsatisfactory engine operation may result.
- Firmly secure the air cleaner.
- Install the exhaust pipe and muffler.

NOTE:

When installing the exhaust pipe, do not forget to install exhaust pipe plates at the two middle exhaust pipe installing portions.

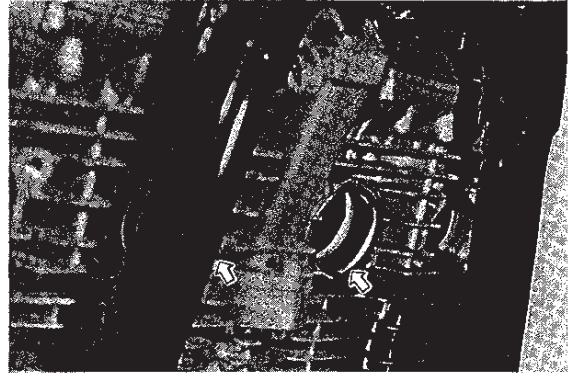

- Before tightening the exhaust pipe bolts, install both right and left muffler mounting bolts loosely.
- After tightening the exhaust pipe bolts, tighten both right and left muffler mounting bolts.

Exhaust pipe bolt tightening torque:	9 – 14 N·m 0.9 – 1.4 kg·m 6.5 – 10.0 lb·ft
--------------------------------------	--

Muffler bolt tightening torque:	18 – 28 N·m 1.8 – 2.8 kg·m 13.0 – 20.0 lb·ft
---------------------------------	--

- Replace the plug caps on the spark plugs so that their code markings correspond to the cylinder numbers arranged in the order of 1, 2, 3, and 4 from the left.
- After remounting the engine, adjust the rear brake pedal, brake light switch, clutch and throttle cable.
- Before starting the engine, make sure the amount of oil required, according to the type of work done, has been put in. Refer to page 14 for quantities.

SECONDARY BEVEL GEAR ASSEMBLY

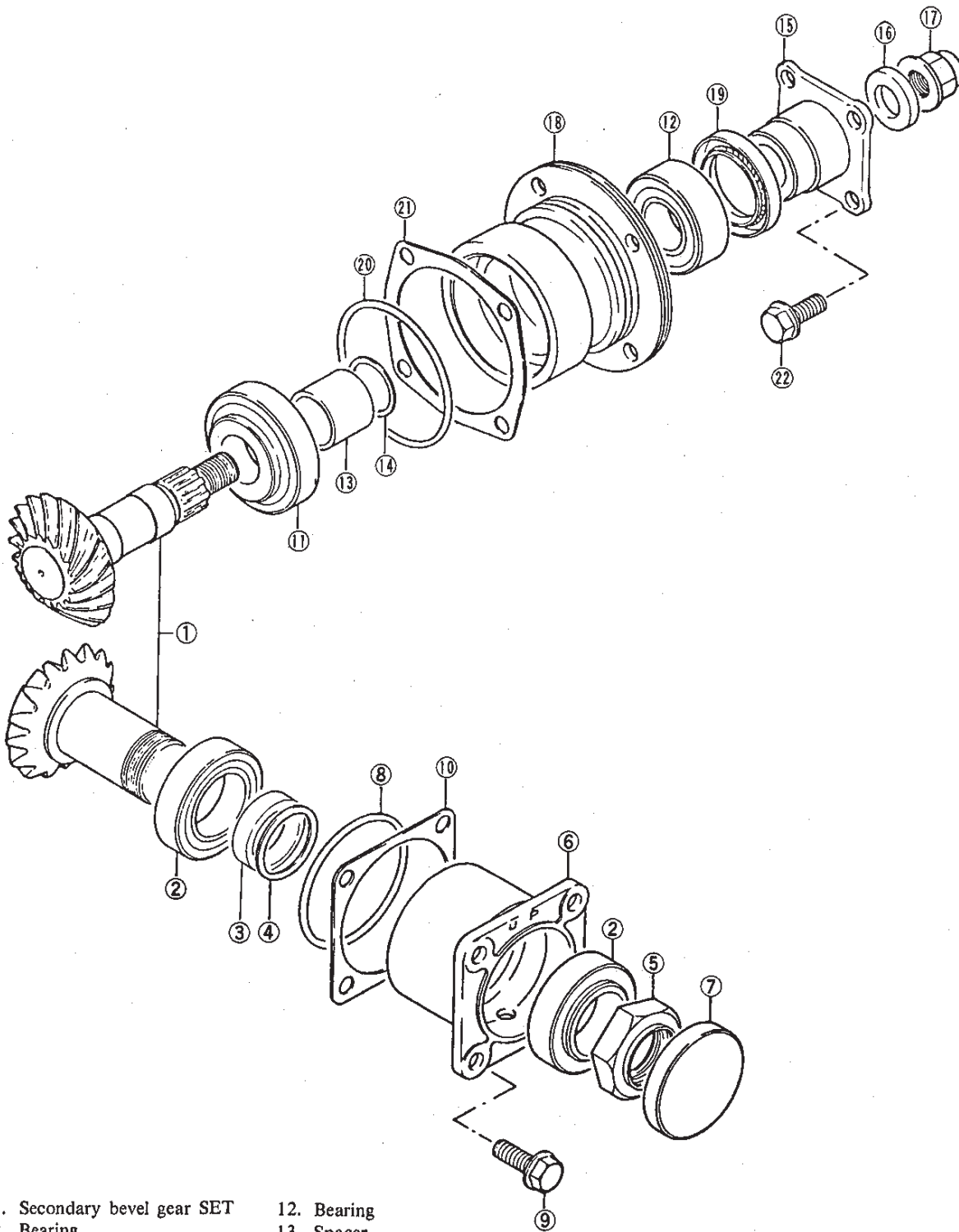

- | | |
|-----------------------------|----------------------------|
| 1. Secondary bevel gear SET | 12. Bearing |
| 2. Bearing | 13. Spacer |
| 3. Spacer | 14. Shim |
| 4. Shim | 15. Universal joint flange |
| 5. Nut | 16. Washer |
| 6. Drive gear housing | 17. Nut |
| 7. Plug | 18. Driven gear housing |
| 8. O ring | 19. Oil seal |
| 9. Bolt | 20. O ring |
| 10. Shim | 21. Shim |
| 11. Bearing | 22. Bolt |

Tightening torque			
	N·m	kg·m	lb·ft
⑤	120 - 150	12.0 - 15.0	87.0 - 108.5
⑨	20 - 26	2.0 - 2.6	14.5 - 19.0
⑰	90 - 110	9.0 - 11.0	65.0 - 79.5
⑳	20 - 26	2.0 - 2.6	14.5 - 19.0

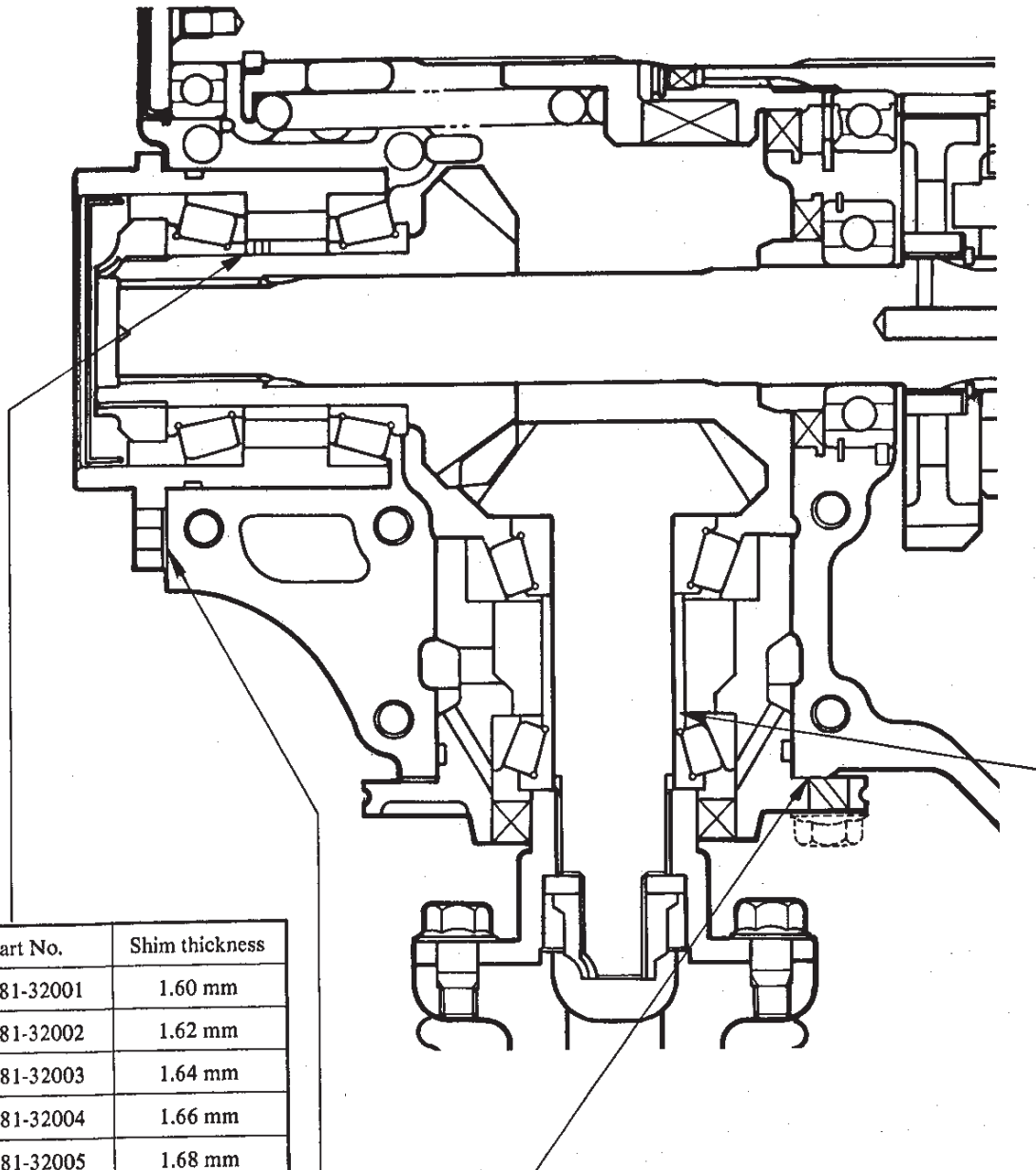

Part No.	Shim thickness
09181-32001	1.60 mm
09181-32002	1.62 mm
09181-32003	1.64 mm
09181-32004	1.66 mm
09181-32005	1.68 mm
09181-32006	1.70 mm
09181-32007	1.80 mm
09181-32008	1.90 mm
09181-32009	2.00 mm

Part No.	Shim thickness
24935-45100	0.35 mm
24935-45102	0.40 mm
24935-45103	0.45 mm
24935-45104	0.50 mm

Part No.	Shim thickness
24945-45100	0.35 mm
24945-45102	0.40 mm
24945-45103	0.50 mm
24945-45104	0.60 mm

Part No.	Shim thickness
09181-25006	1.60 mm
09181-25007	1.62 mm
09181-25008	1.64 mm
09181-25009	1.66 mm
09181-25010	1.68 mm
09181-25011	1.70 mm
09181-25012	1.80 mm
09181-25013	1.90 mm
09181-25014	2.00 mm

SECONDARY DRIVE GEAR ASSEMBLY

REMOVAL AND DISASSEMBLY

- Remove the secondary unit cover; remove drain plug and drain oil into a pan.
- Remove the four mounting bolts and remove the secondary drive gear housing from the crankcase.
- Using a drift, knock the plug out of the housing

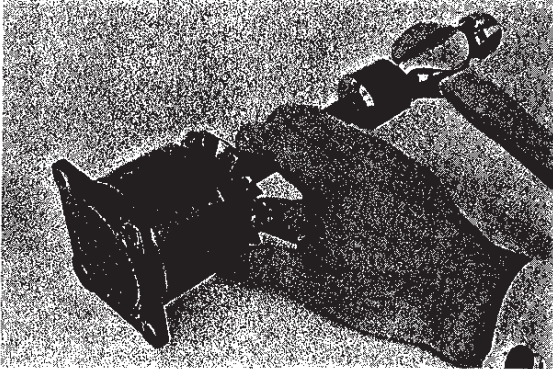

- Straighten the bent area of the nut. Use special tool ① to lock the drive gear, and special tool ② to remove the nut.

①	Secondary drive bevel gear holder	09924-54510
②	41 mm socket wrench	09910-23710

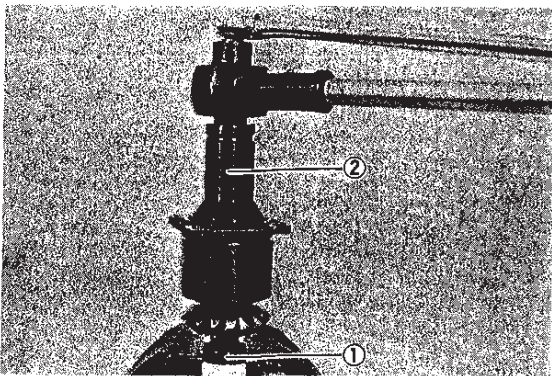

- Tap the drive gear with a plastic hammer to remove it from the housing.

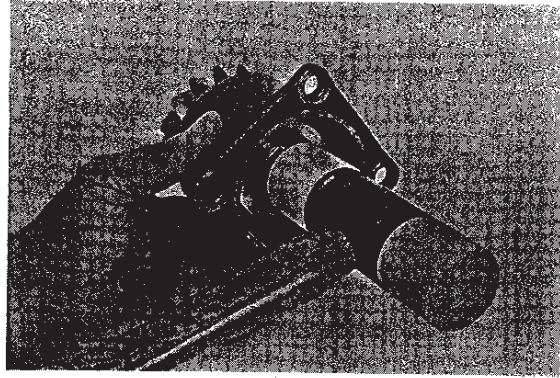

- Remove the shims from the drive gear shaft. Do not discard. Note the location.
- Use special tool ③ to remove the inner bearing race from drive gear.

Bearing inner race remover:	09941-84510
-----------------------------	-------------

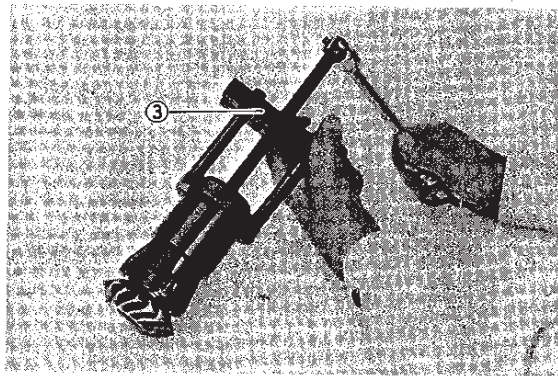

- Use special tools ④ and ⑤ to remove the bearing outer races from the housing.

④	Bearing outer race remover	09941-54911
⑤	Bearing installer	09913-84510

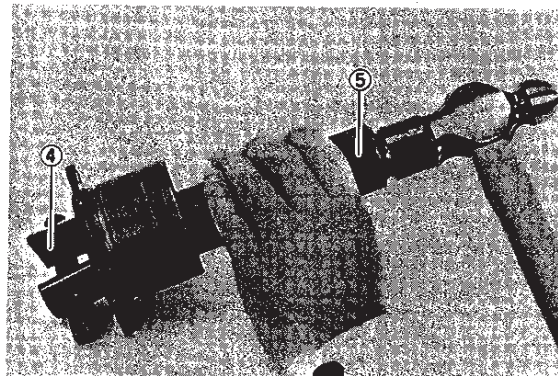

INSPECTION AND REASSEMBLY

NOTE:

Before reassembly, clean all parts in solvent.

NOTE:

It will be helpful to have a selection of all shims on hand before beginning bearing preload adjustment.

- Use special tool ① to install the outer bearing races into the drive gear housing.

Bearing installer set:	09924-84510
------------------------	-------------

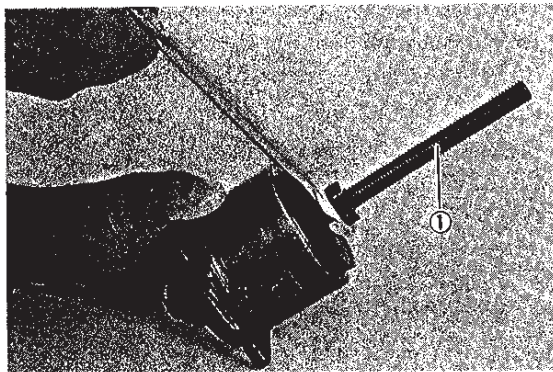

- Use special tool ② to install the inner bearing race on the drive gear shaft.

Bearing installer:	09913-84510
--------------------	-------------

CAUTION:

If replacing the secondary drive gear, be sure to replace secondary driven gear also, as they must be replaced together.

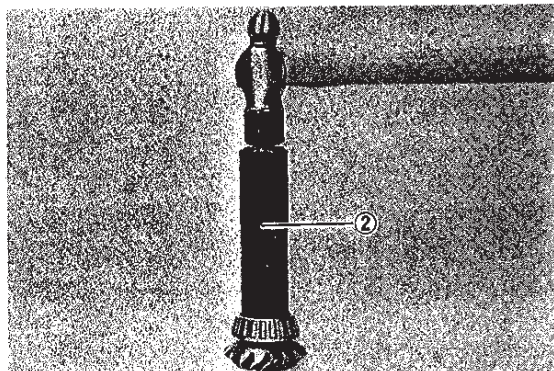

- Install all the shims, removed during disassembly, on the drive gear shaft.

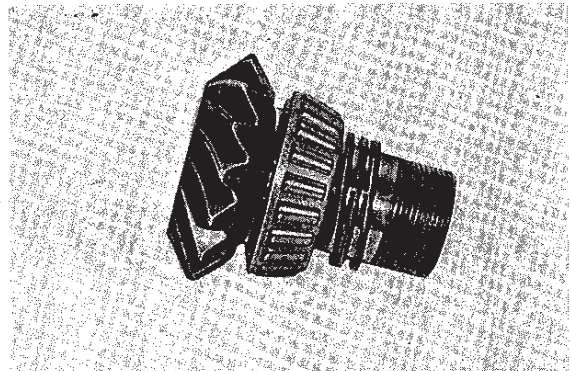

- Install the drive gear into the housing and install the other inner bearing race and nut. Oil the bearings with Hypoid gear oil.
- Use special tool ③ to lock the gear, and special tool ④ to tighten nut to specification.

③	Secondary drive bevel gear holder	09924-54510
④	41 mm socket wrench	09910-23710

NOTE:

Always use a new nut.

Nut tightening torque:	120 — 150 N·m
	12 — 15 kg·m
	87.0 — 108.5 lb·ft

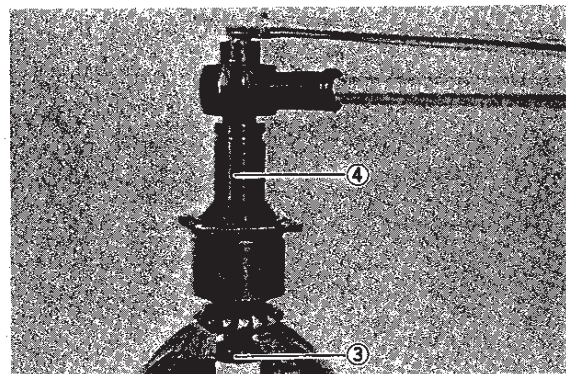

BEARING PRELOAD ADJUSTMENT

- After tightening the nut to specification, rotate the drive gear several turns in both directions to seat the bearings.
- Use special tools to measure the torque necessary to turn the gear. This is the bearing preload.

①	Torque wrench 0 — 15 kg·cm	09900-21107
②	41 mm socket wrench	09910-23710

Preload	30 — 50 N·cm 3 — 5 kg·cm 2.60 — 4.35 lb·in
---------	--

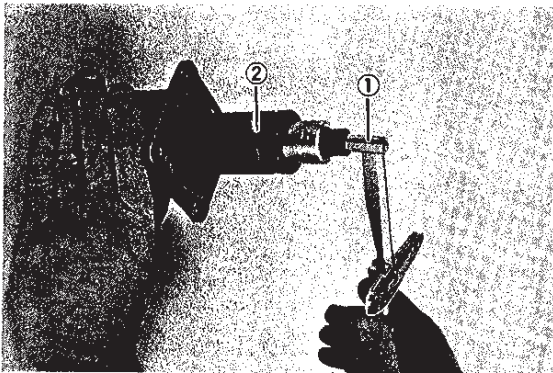

If the bearing preload is not within specification, the shims between the bearings must be changed. Refer to the chart below and make appropriate adjustments, repeating the preload checking procedure as necessary.

NOTE:

Each time the preload is checked after a shim change, the gear must be rotated in both directions to seat the bearings after the nut is retorqued to specification.

Preload	Adjustment by shim
Under 3 kg·cm	Decrease shim thickness
3 — 5 kg·cm (2.60 — 4.35 lb·in)	Correct
Over 5 kg·cm	Increase shim thickness

Part No.	Shim thickness
09181-32001	1.60 mm
09181-32002	1.62 mm
09181-32003	1.64 mm
09181-32004	1.66 mm
09181-32005	1.68 mm
09181-32006	1.70 mm
09181-32007	1.80 mm
09181-32008	1.90 mm
09181-32009	2.00 mm

- After the bearing preload has been adjusted to within specification, remove the drive gear nut, clean and degrease the threads on the drive gear shaft, install the nut, and torque to specification.

Nut tightening torque	120 — 150 N·m 12 — 15 kg·m 87.0 — 108.5 ft·lb
-----------------------	---

- Bend the collar of the nut over into the notch in the drive gear shaft.
- Press a new plug into the secondary drive gear housing so that it is 1.5 mm below the housing shoulder.

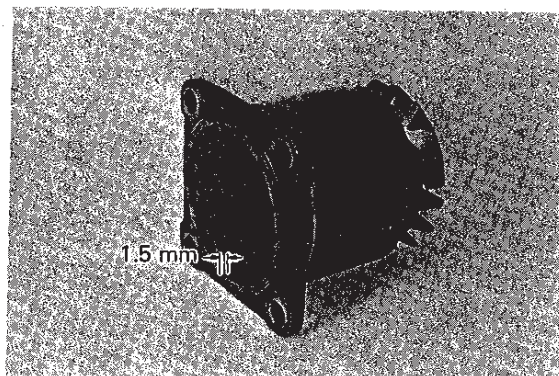

- The secondary drive gear assembly is now ready for installation into the crankcase. For backlash and tooth contact adjustments, see pages 38 and 39.

SECONDARY DRIVEN GEAR ASSEMBLY

REMOVAL AND DISASSEMBLY

- Remove engine assembly from the frame.
- Remove drive unit cover and drain secondary gear oil into a pan.
- Remove the four secondary driven gear housing bolts and remove the assembly from the crankcase.

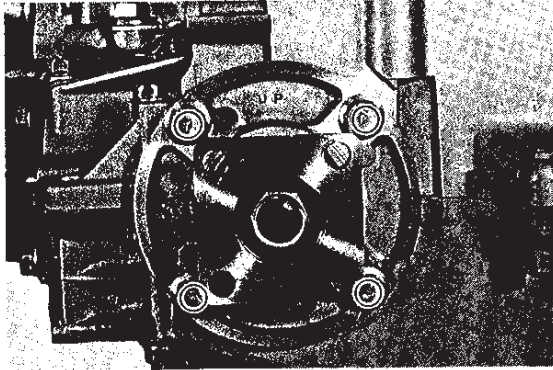

- Secure the propeller shaft flange in a vise and straighten the bent portion of the driven gear nut. Remove the nut.

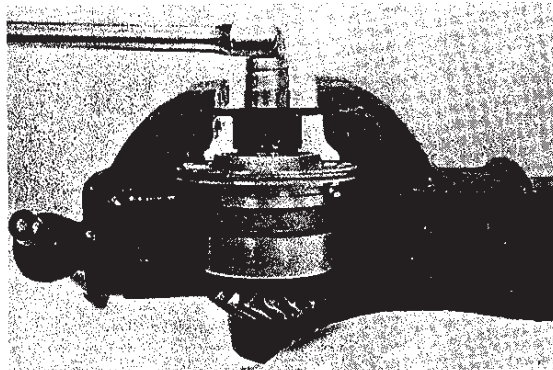

- Remove the flange from the driven gear.
- Tap the driven gear with a plastic hammer to remove it from the housing.
- To remove the oil seal from the housing, use special tools ① and ②.

①	Bearing and oil seal remover	09941-64510
②	Rotor remover shaft set	09930-30102

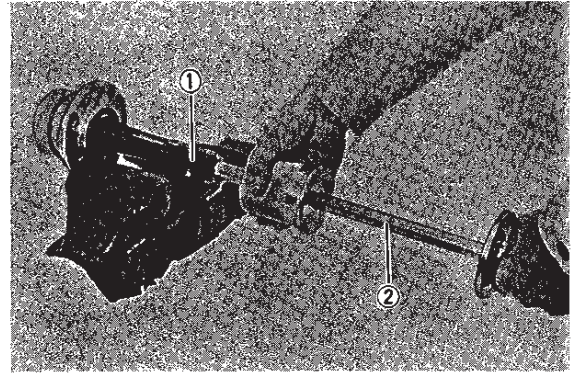

- Remove the spacer and shims from the driven gear shaft. Do not discard them.
- Use special tool ③ to remove the inner bearing race from the driven gear.

Bearing inner race remover	09941-84510
----------------------------	-------------

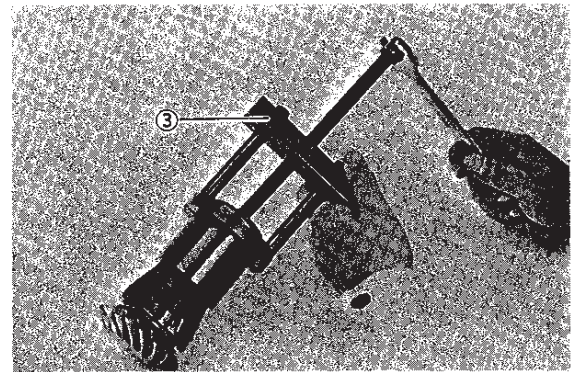

- Use special tool ④ to remove the outer bearing races from the housing.

Bearing outer race remover	09941-54911
----------------------------	-------------

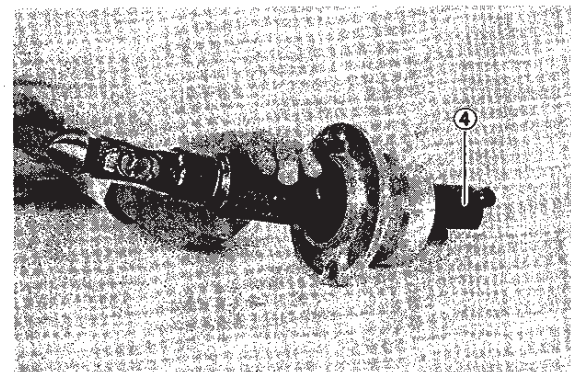

INSPECTION AND REASSEMBLY

NOTE:

Before reassembly, clean all parts in solvent.

NOTE:

It will be helpful to have a selection of all shims available for bearing preload operation.

- Use special tool ① to install the outer bearing races into the secondary driven gear housing.

Bearing installer set	09924-84510
-----------------------	-------------

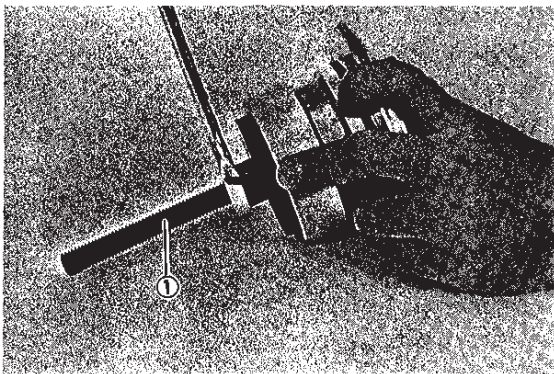

- Use special tool ② to install the inner bearing race onto the driven gear.

CAUTION:

If replacing the secondary driven gear, be sure also to replace the secondary drive gear, as they must be replaced together.

Drive pinion race installer	09913-80112
-----------------------------	-------------

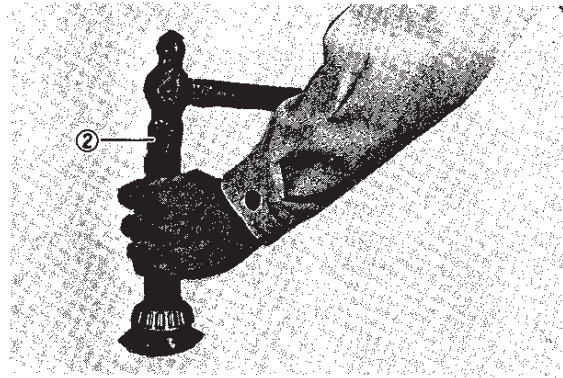

- Install the spacer and shims, removed during disassembly, onto the driven gear shaft.
- Lubricate the bearings with Hypoid gear oil and install the secondary driven gear and bearings into the housing.

NOTE:

No oil seal is installed at this point. Oil seal is installed after bearing preload is correct.

- Install the propeller shaft flange, washer, and nut on the driven gear, and tighten the nut to specification.

NOTE:

Always use a new nut.

Nut tightening torque	90 – 110 N·m 9 – 11 kg·m 65.0 – 79.5 lb·ft
-----------------------	--

BEARING PRELOAD ADJUSTMENT

- After the nut is tightened to specification, turn the gear several turns in both directions to seat the bearings.
- Use a torque wrench ① and a socket to measure the torque necessary to turn the gear. This is the bearing preload.

①	Torque wrench 0 — 15 kg•cm	09900-21107
---	----------------------------	-------------

Preload	40 — 70 N•cm
	4.0 — 7.0 kg•cm
	3.45 — 6.05 lb•in

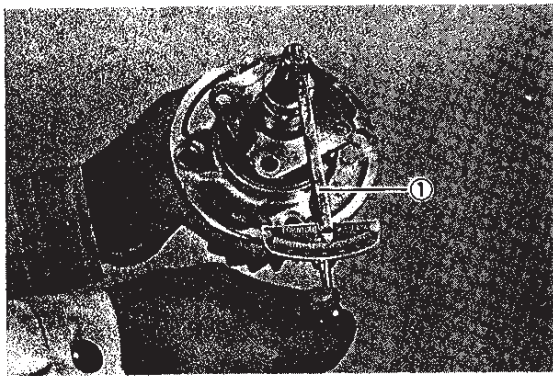

- If the bearing preload is not within specification, the shims between the bearings must be changed. Refer to the chart below to make appropriate adjustments, repeating the preload checking procedure as necessary.

NOTE:

Each time the preload is checked after a shim change, the gear must be rotated in both directions to seat the bearings after the nut is retorqued to specification.

Preload	Shim Adjustment
Under 4 kg•cm	Decrease shim thickness
4 — 7 kg•cm (3.45 — 6.05 lb•in)	Correct
Over 7 kg•cm	Increase shim thickness

List of shims

Part No.	Shim thickness
09181-25006	1.60 mm
09181-25007	1.62 mm
09181-25008	1.64 mm
09181-25009	1.66 mm
09181-25010	1.68 mm
09181-25011	1.70 mm
09181-25012	1.80 mm
09181-25013	1.90 mm
09181-25014	2.00 mm

- After the bearing preload has been adjusted to within specification, remove the driven gear nut, washer, and propeller shaft flange.
- Install a new oil seal into the secondary driven gear housing, making it flush with housing shoulder.
- Clean and degrease the driven gear shaft threads, apply a small amount of THREAD LOCK SUPER "1361A" to the threads and install the propeller shaft flange, washer, and nut.
Tighten the nut to specification.

Thread Lock Super "1361A"	99104-32020
---------------------------	-------------

Nut Tightening Torque	90 — 110 N•m
	9.0 — 11.0 kg•m
	65 — 79.5 lb•ft

- Bend the collar of the nut over into the notch in the driven gear shaft.
- The secondary driven gear assembly is now ready for installation into the crankcase for backlash and tooth contact adjustments as shown below.

SECONDARY GEAR SET CLEARANCING OPERATIONS

BACKLASH

- Install the housing shims removed during disassembly onto secondary drive gear housing and secondary driven gear housing.

NOTE:

No o-rings are used at this stage.

- Install drive and driven gear housing into crankcase and tighten four bolts on each to specification.

CAUTION:

Secondary drive and driven gear housings must be installed with letters "up" facing upward as shown in Fig. A and B.

Bolt tightening torque	20 — 26 N·m 2.0 — 2.6 kg·m 14.5 — 19.0 lb·ft
------------------------	--

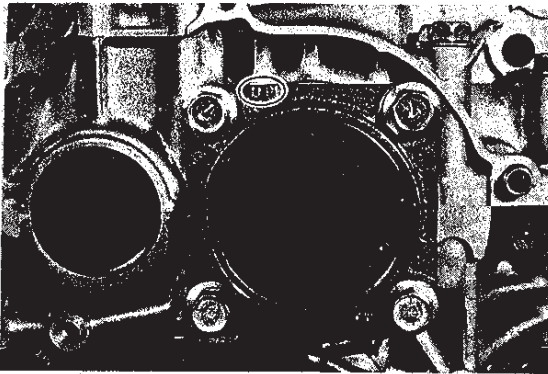

Fig. A

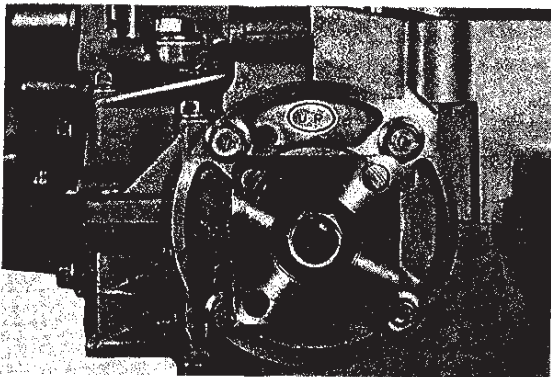
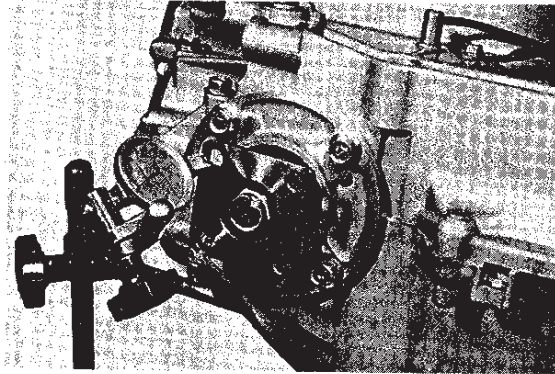

Fig. B

- Attach a dial gauge as shown to the secondary driven gear flange and measure the backlash by turning the flange and measure the backlash by turning the flange in each direction until it stops.

Secondary Driven Gear Backlash	0.08 — 0.13 mm (0.003 — 0.005 in)
--------------------------------	--------------------------------------



- If the backlash is not within specification, the shim between the secondary driven gear housing and crankcase must be changed and the backlash rechecked until correct. Refer to the table below for appropriate changes.

Backlash	Shim adjustment
Under 0.08 mm	Increase shim thickness
0.08 — 0.13 mm (0.0031 — 0.0051 in)	Correct
Over 0.13 mm	Decrease shim thickness

List of Shims

Part No.	Shim thickness
24945-45100	0.35 mm
24945-45102	0.40 mm
24945-45103	0.50 mm
24945-45104	0.60 mm

TOOTH CONTACT CHECKING

- After bringing the backlash within specification by changing the shim between the secondary driven gear housing and crankcase, it will be necessary to check tooth contact.
- Remove the four bolts and remove the secondary driven gear housing from the crankcase.
- Clean and degrease the secondary driven gear teeth, and apply a coating of machinist's layout dye or paste to several teeth
- Reinstall the secondary driven gear housing, with correct shim, into the crankcase, and torque the bolts to specification.

NOTE: No o-ring is used at this stage.

Bolt Tightening Torque	20 – 26 N·m
	2.0 – 2.6 kg·m
	14.5 – 19.0 ft·lb

- Turn the secondary driven gear flange several turns in both directions.
- Remove the secondary driven gear housing from the crankcase, and observe the tooth contact pattern made in the dye or paste.
- Compare the tooth contact pattern to the examples as shown in ①, ②, ③.

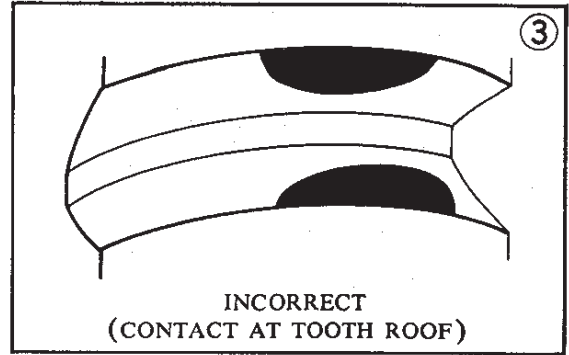
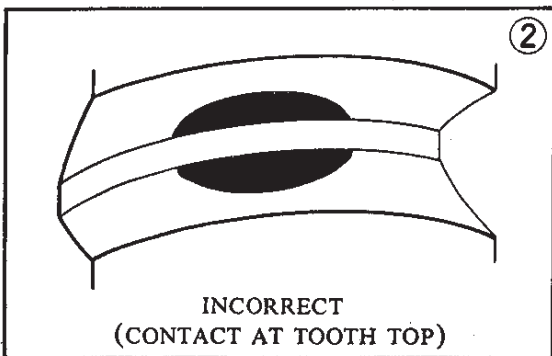
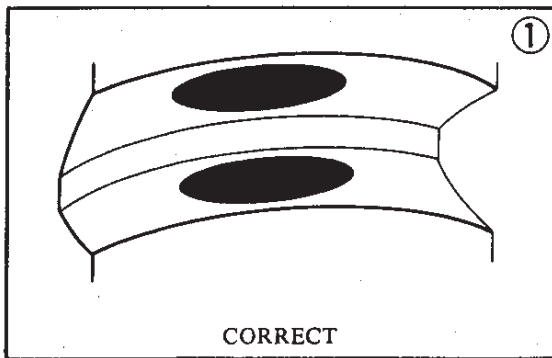

- If tooth contact is found to be correct, go the Final Assembly sub-section, and complete.
- If tooth contact is found to be incorrect, the shim between the secondary drive gear housing and crankcase must be changed, and tooth contact rechecked, until correct.

Tooth contact	Shim thickness
Contact at tooth top ②	Decrease shim thickness
Contact at tooth roof ③	Increase shim thickness

List of shims

Part No.	Shim thickness
24935-45100	0.35 mm
24935-45102	0.40 mm
24935-45103	0.45 mm
24935-45104	0.50 mm

CAUTION:

After the tooth contact adjustment is made, the backlash must be rechecked, as it may change. Refer to the backlash checking subsection, and readjust until both backlash and tooth contact are correct.

FINAL ASSEMBLY

- After both gear backlash and tooth contact are correct, remove the secondary drive gear housing and secondary driven gear housing from the crankcase.
- Clean off any machinist's dye or past from the gear teeth, and lubricate the teeth with Hypoid gear oil.
- Install new o-rings on the secondary drive and driven gear housings. Lightly grease the o-rings.
- Install the secondary drive and driven gear housings into the crankcase.

NOTE:
Secondary drive and driven gear housings must be installed with the letters "UP" facing upward, as shown in Fig. A and B (page 38)

- Use THREAD LOCK "1363C" on the threads of the housing bolts, and torque to specification.

Thread Lock "1363C"	99104-32050
---------------------	-------------

Bolt Tightening Torque	20 – 26 N·m
	2.0 – 2.6 kg·m
	14.5 – 19.0 ft·lb

- Reinstall secondary gear drain plug and torque to specification.

Drain Plug Torque	20 – 30 N·m
	2.0 – 3.0 kg·m
	14.5 – 21.5 ft·lb

- Fill the gear cavity to specified capacity, 340 – 400 ml (11.5 – 13.5 US oz) with Hypoid gear oil.
- Remounting engine assembly, see page 29.
- Reinstall secondary drive gear outer cover.

CLUTCH

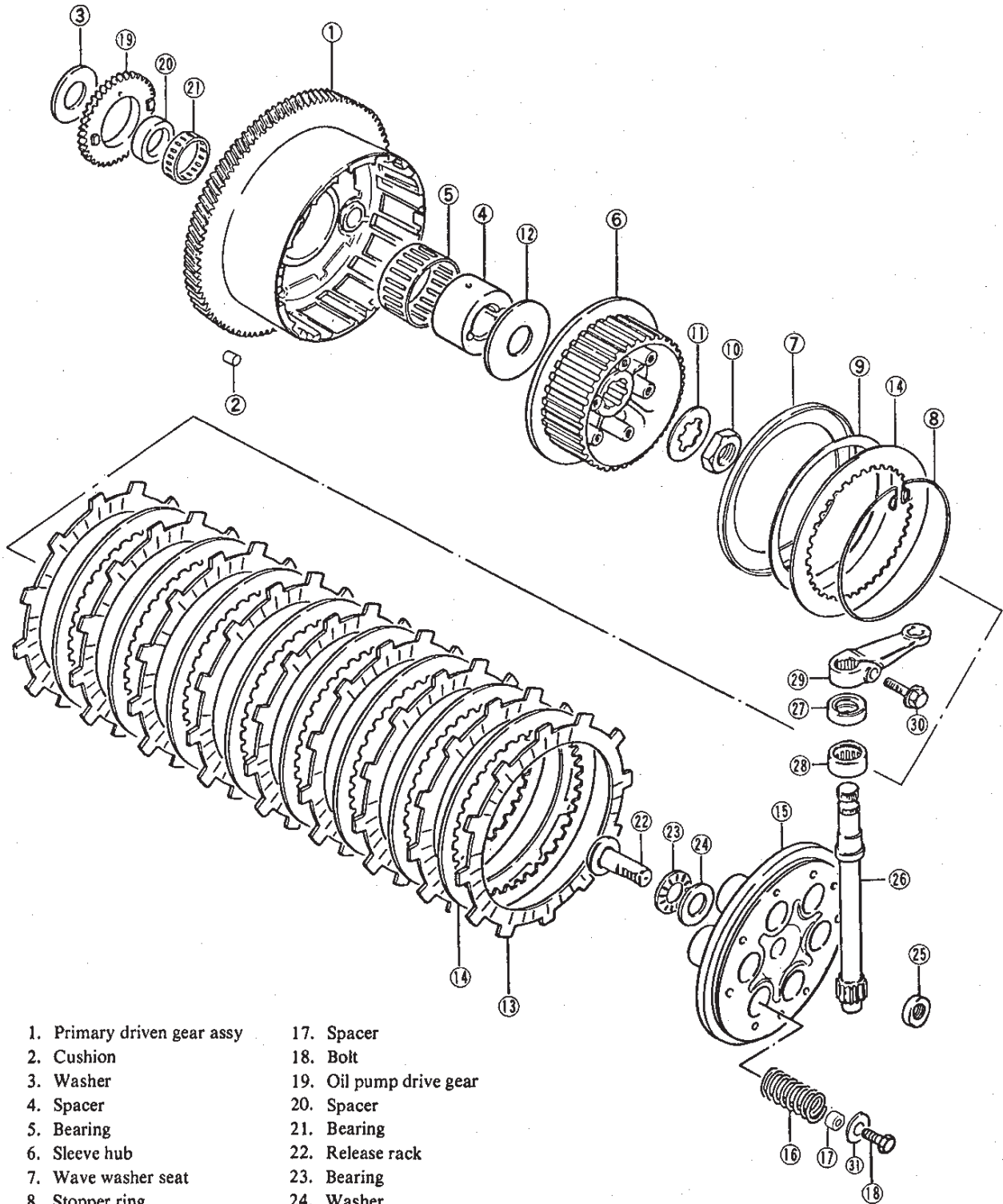

- | | |
|-----------------------------|-------------------------|
| 1. Primary driven gear assy | 17. Spacer |
| 2. Cushion | 18. Bolt |
| 3. Washer | 19. Oil pump drive gear |
| 4. Spacer | 20. Spacer |
| 5. Bearing | 21. Bearing |
| 6. Sleeve hub | 22. Release rack |
| 7. Wave washer seat | 23. Bearing |
| 8. Stopper ring | 24. Washer |
| 9. Wave washer | 25. Oil seal |
| 10. Nut | 26. Release pinion |
| 11. Washer | 27. Oil seal |
| 12. Washer | 28. Bearing |
| 13. Drive plate | 29. Release arm |
| 14. Driven plate | 30. Bolt |
| 15. Pressure plate | 31. Washer |
| 16. Spring | |

Tightening torque			
	N·m	kg·m	lb·ft
⑩	50 - 70	5.0 - 7.0	36.0 - 50.5
⑱	8 - 12	0.8 - 1.2	6.0 - 8.5
⑳	6 - 10	0.6 - 1.0	4.5 - 7.0

DISASSEMBLY

- Remove the cam lever bolts for clutch cable and clutch cover screw.

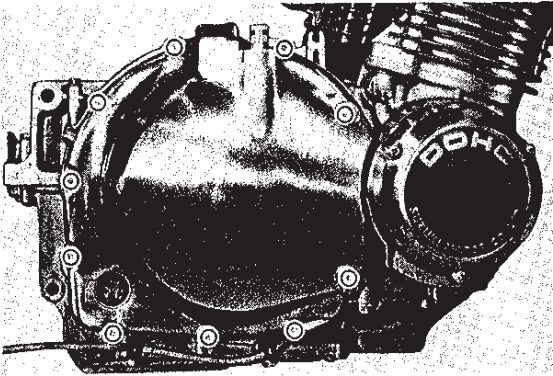

- Remove clutch cover and gasket.
- Remove clutch spring mounting bolts and remove spring, spacer and pressure plate.

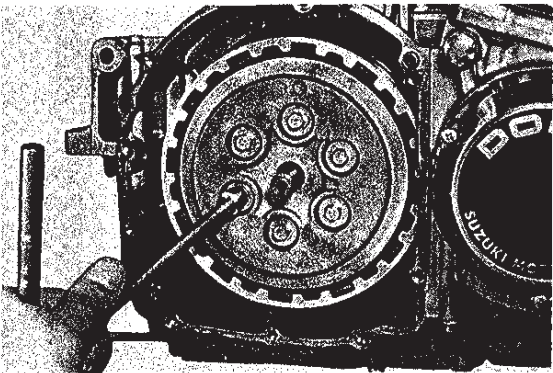

- Remove clutch release rack ①, needle bearing ② and washer ③ from pressure plate.

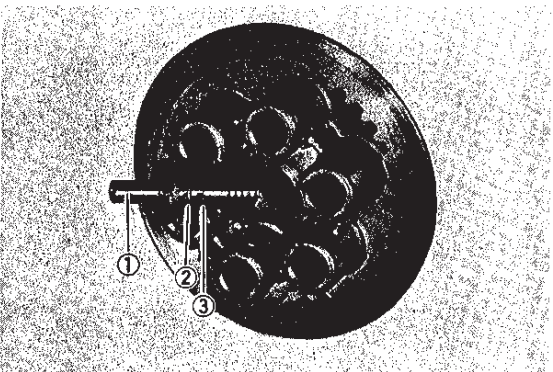

- After removal of several clutch drive and driven plates, firmly secure clutch sleeve hub to remove mounting nut with special tool ④.

Clutch sleeve hub holder:

09920-53710

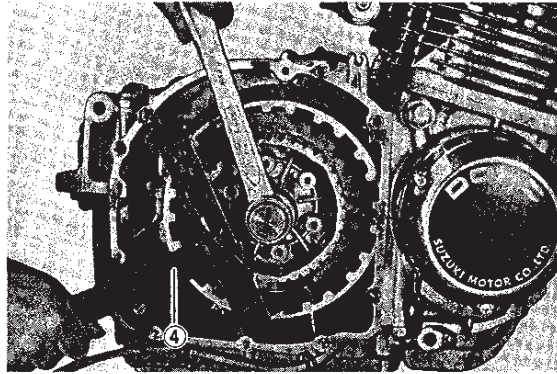

- Remove washer, sleeve hub and the remaining plates.
Screw two 6 mm screws into the primary driven gear spacer and pull the spacer out. With the spacer removed, the primary driven gear (integral with the clutch housing) is free to disengage from the primary drive gear.

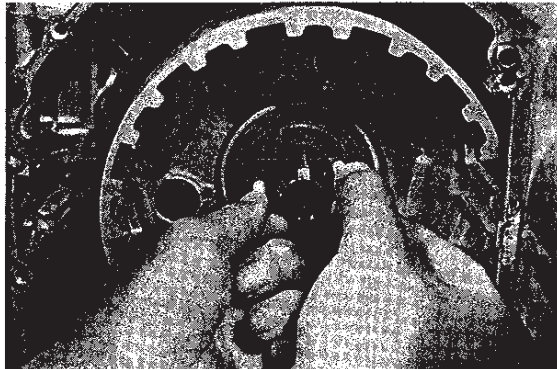

- Grip the driven plate with pliers and remove the piano wire clip. Next, pull out the driven plate, spring and spring seat from the driven plate, spring and spring seat from the clutch sleeve hub.

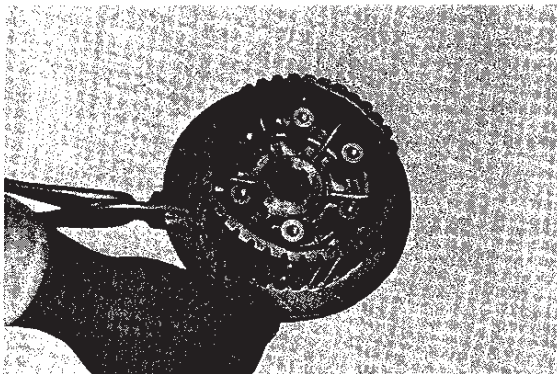

INSPECTION

DRIVE PLATE THICKNESS

Measure the thickness of each drive plate with vernier calipers. Replace drive plates found to have worn down to the limit.

Standard	Limit
2.9 – 3.1 mm (0.11 – 0.12 in)	2.6 mm (0.10 in)

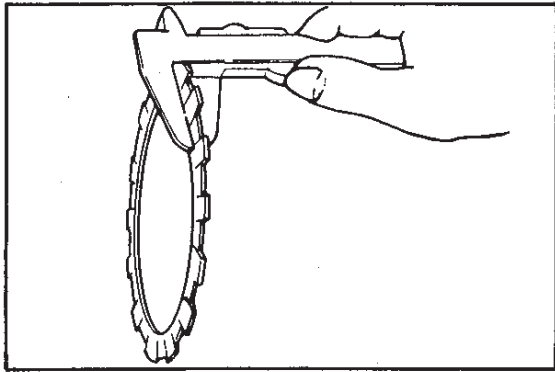

DRIVE PLATE CLAW WIDTH

Using vernier calipers, measure the drive plate claw width. If it measures less than the limit, replace the drive plate.

Drive plate claw width

Standard	Limit
15.6 – 15.8 mm (0.61 – 0.62 in)	14.8 mm (0.58 in)

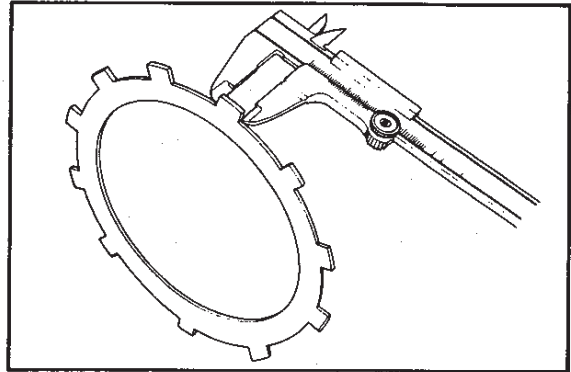

CLUTCH PLATE DISTORTION

Check driven plate for distortion by placing it on a surface plate and by inserting a thickness gauge under the plate at several places.

The distortion limit in terms of clearance specified as follows:

Driven plate distortion

Limit	0.1 mm (0.004 in)
-------	-------------------

Be sure to replace any plates exceeding this limit.

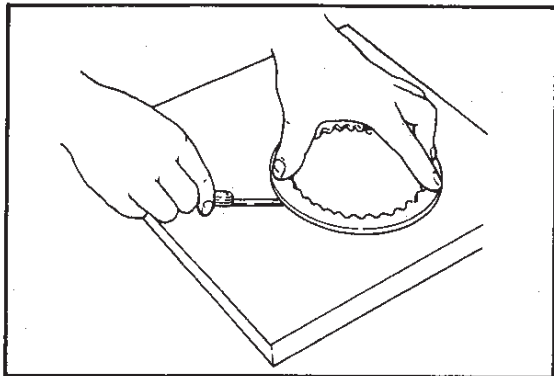

CLUTCH SPRING FREE LENGTH

Measure the free length of each coil spring with vernier calipers and compare the compressed strength of each with the specified limit. Replace any spring not within the limit.

Clutch spring free length

Limit	38.5 mm (1.52 in)
-------	-------------------

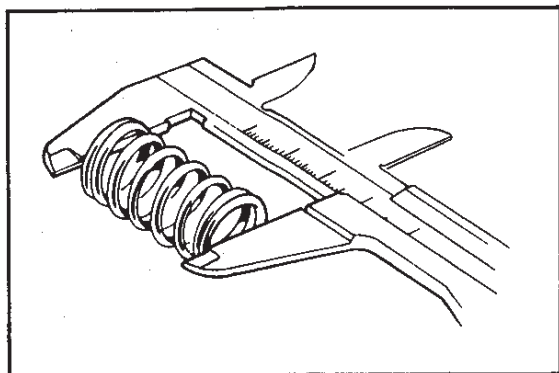

INSTALLATION

- Fit the projection of oil pump drive gear into the notch of primary driven gear and confirm both parts fit snugly while rotating primary driven gear left and right.

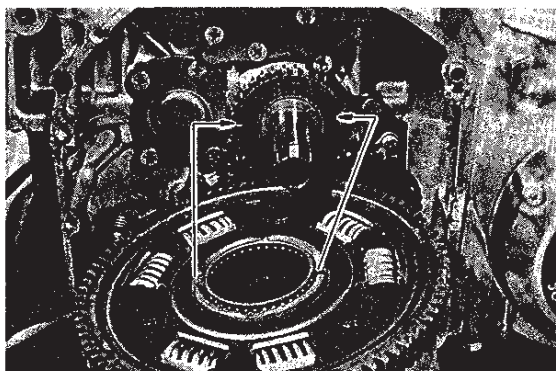

- After installing the oil pump drive gear and primary driven gear, apply engine oil to needle bearing and spacer to assemble the needle bearing and the spacer in the prescribed order.
- Assemble the primary driven gear and then thrust washer must be installed with the grooved side facing in.



CORRECT

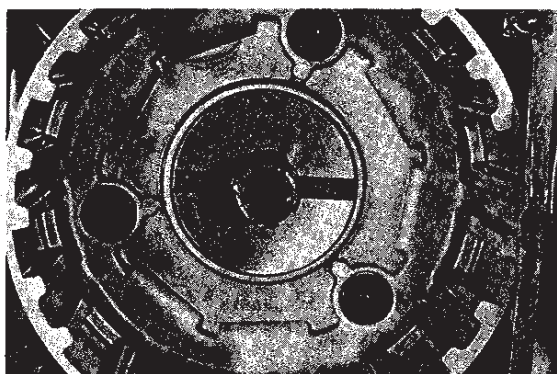

INCORRECT

- Install the spring seat, spring and driven plate in the clutch sieve hub. Check that these three parts are positioned correctly as illustrated below.

While holding the driven plate with pliers, install the piano wire clip.

NOTE:

Always use a new piano wire clip.

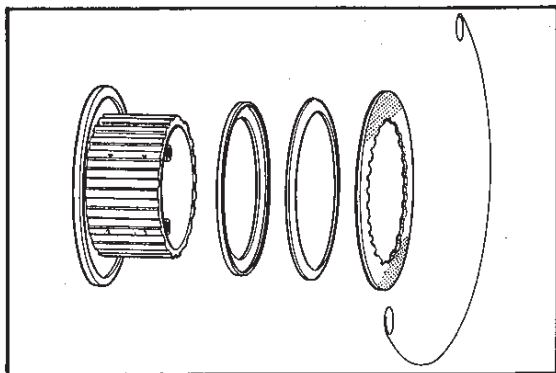

- After tightening the clutch sleeve hub nut, be sure to lock the nut by firmly bending the tongue of the washer. Tightening torque for the nut is specified.

Clutch sleeve hub nut tightening torque	50 — 70 N·m
	5.0 — 7.0 kg·m
	36.0 — 50.5 lb·ft

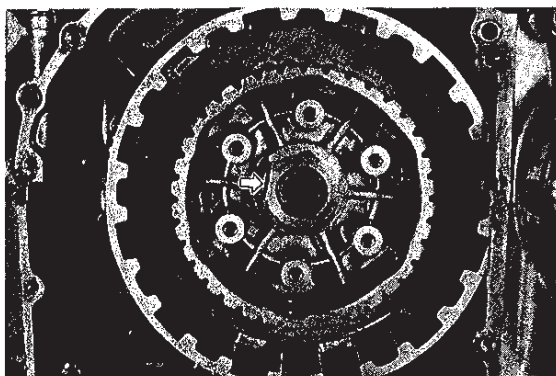

- Insert clutch drive plate and driven plate one by one into sleeve hub in the prescribed order. Insert clutch release rack, bearing and thrust washer into pressure plate, making sure that the thrust washer is between the bearing and the pressure plate, then fit pressure plate into sleeve hub.

- Tighten clutch spring bolts in the order shown in the photo.

NOTE:

Tighten the clutch spring set bolts in the manner indicated, tightening them by degrees until they attain a uniform tightness.

Clutch spring bolt tightening torque	11 — 13 N·m
	1.1 — 1.3 kg·m
	8.0 — 9.5 lb·ft

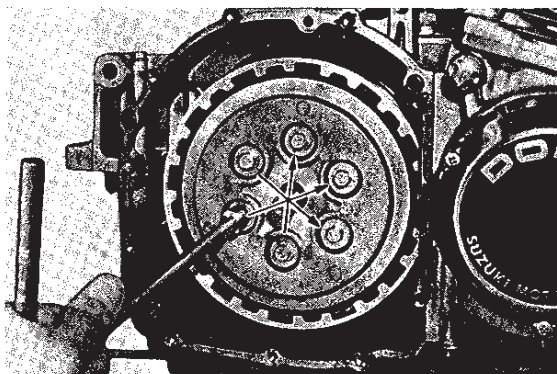

- Replace clutch cover gasket with new one to prevent oil leakage.
- Engage the teeth of clutch release rack with those of pinion gear at the clutch cover side and replace clutch cover. Make sure that the rack and pinion gear engage positively. To install cover, tap lightly with plastic hammer and tighten screws.

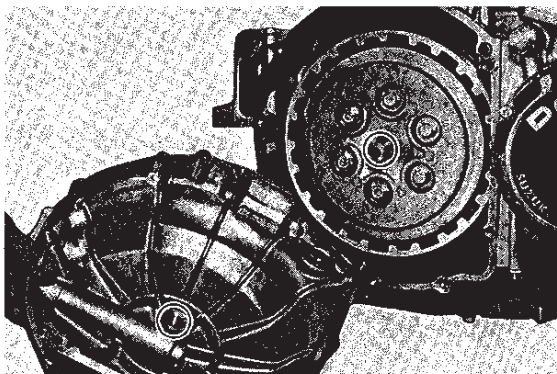

CRANKCASE

DISASSEMBLY

- Remove the cylinder head cover and cylinder head assembly.
- Remove the cylinder and four pistons
- Remove the clutch cover and then remove the clutch assembly.
- Remove the signal generator cover and then remove the signal generator and timing plate.
- Remove the generator cover and then generator rotor.
- Remove the starter motor.
- Gear shift cam guide screw ①
..... 2 pcs. (overall length 12 mm)
- Gear shift pawl screw ②
..... 2 pcs. (overall length 12 mm)
- Counter shaft B/g retainer screw ③
..... 3 pcs. (overall length 16 mm)
- Drive shaft plate screw ④
..... 4 pcs. (overall length 16 mm)
- Oil pump gallery plate screw ⑤
..... 3 pcs. (overall length 16 mm)
- Oil pump mounting screw ⑥
..... 3 pcs. (overall length 25 mm)

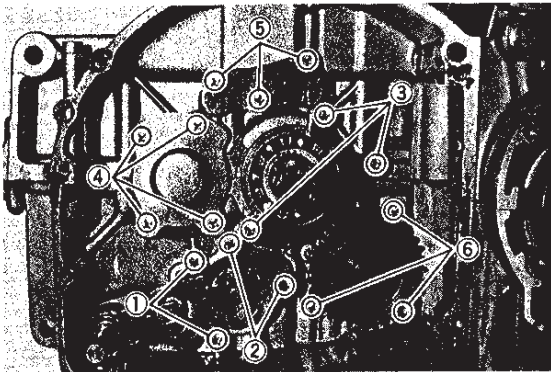

- Remove the gear shifting shaft and then cam driven gear shifting pawls No. 1 and No. 2.
- Remove oil pump
- Remove upper crankcase tightening bolts.
6 mm bolt 12 pcs.
8 mm bolt 5 pcs.

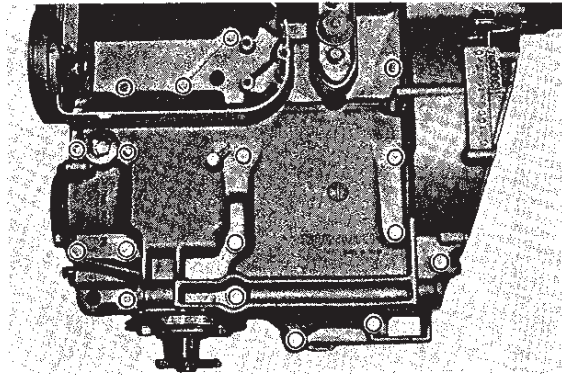

- Next turn engine upside down to remove oil pan from lower crankcase.

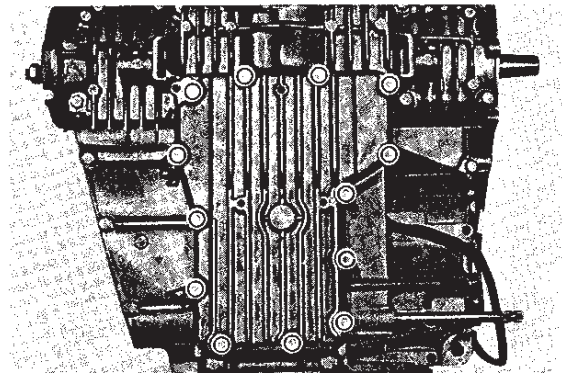

- After removal of oil pan, remove lower crankcase tightening bolts.
6 mm bolt 9 pcs.
8 mm bolt 12 pcs.

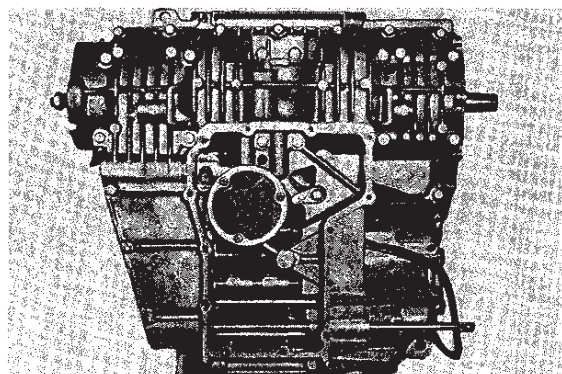

- Make sure that bolts are removed. Lightly hammer the lower crankcase side with a plastic hammer to separate the upper and lower crankcase halves and then lift the latter.
- Remove the crankshaft sub-assembly, counter shaft gear, drive shaft gear, secondary drive bevel gear and secondary driven bevel gear which are all mounted on the upper crank case.
At this time be careful not to drop "C" rings and the like.

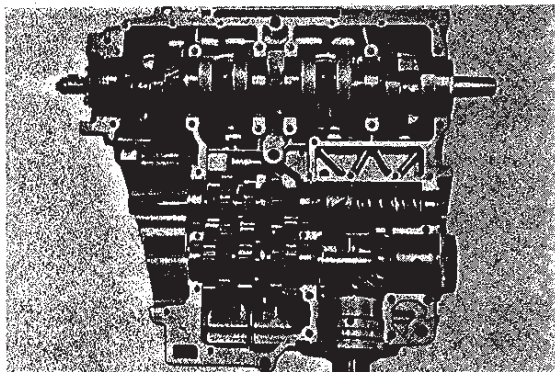

- Remove cam stopper holder to remove cam stopper and spring.

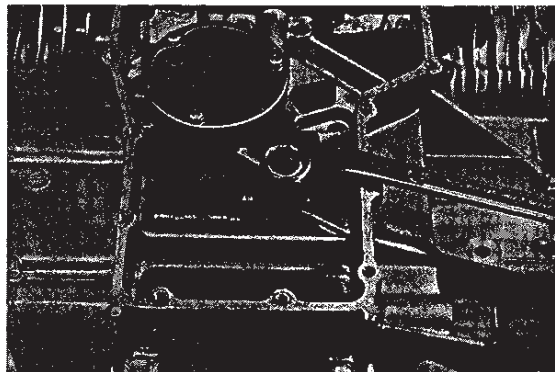

- Extract gear shifting cam to the right side.

- Hold gear shifting forks by hand to extract gear shifting fork shafts from the lower crankcase.

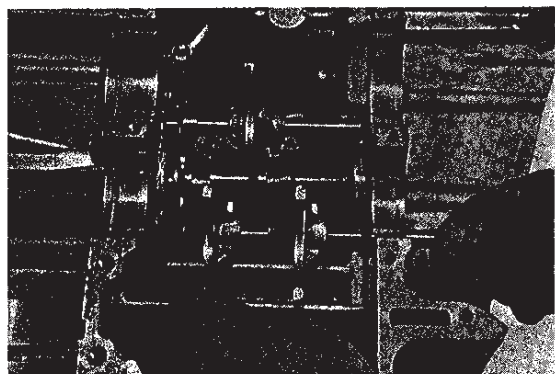

TRANSMISSION

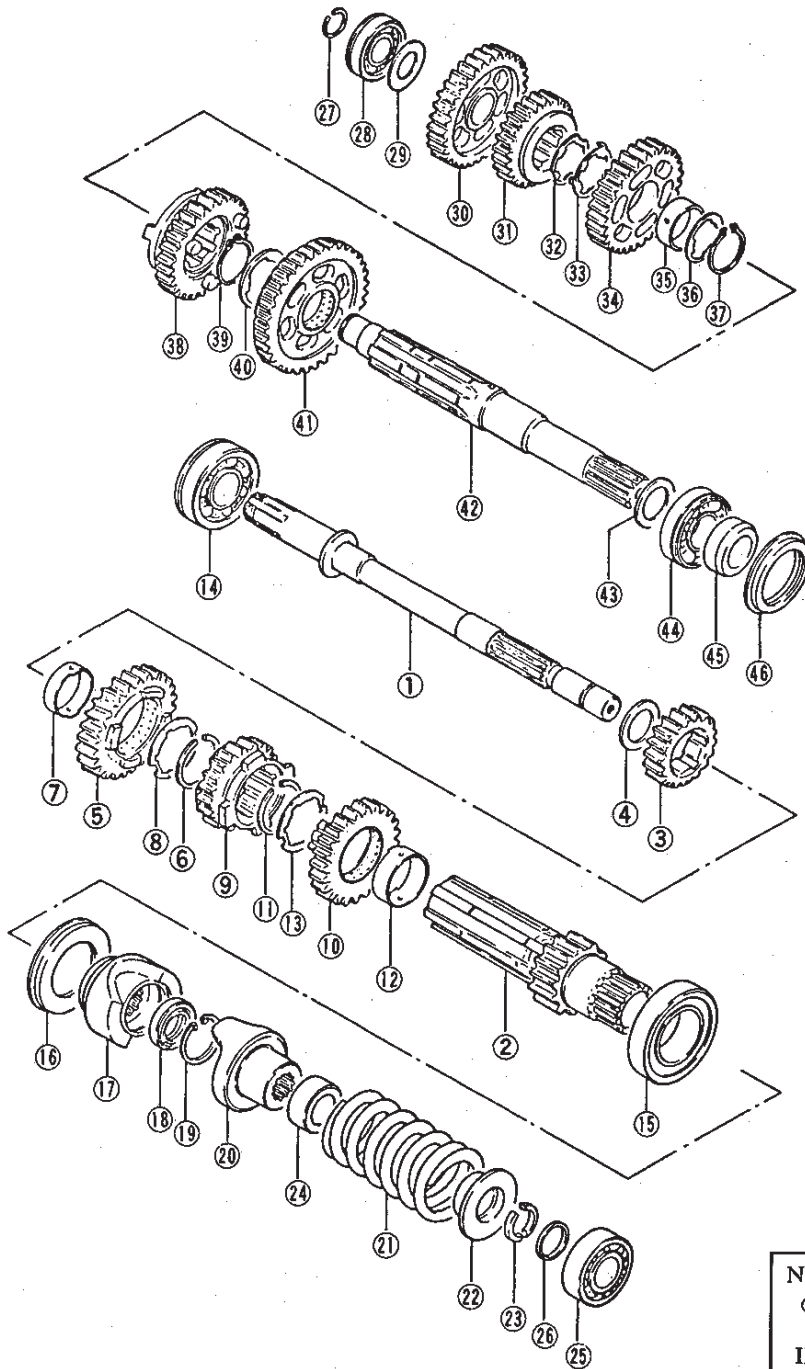

NOTE:
 ○ × ○ × ○
 | | |
 ID OD L

- | | | | |
|-----------------------------|---------------------|----------------------------|---------------------|
| 1. Inner countershaft | 13. Lock washer | 25. Bearing | 37. Circlip |
| 2. Outer countershaft | 14. Bearing | 26. Spacer (17 × 21 × 3.5) | 38. 4th driven gear |
| 3. 2nd drive gear | 15. Bearing | 27. Circlip | 39. Circlip |
| 4. Washer | 16. Oil seat | 28. Bearing | 40. Washer |
| 5. 5th drive gear | 17. Output cam dog | 29. Washer | 41. 1st driven gear |
| 6. Circlip | 18. Oil seal | 30. 2nd driven gear | 42. Drive shaft |
| 7. Spacer (32 × 36 × 13.4) | 19. Circlip | 31. 5th driven gear | 43. Washer |
| 8. Lock washer | 20. Input cam dog | 32. Washer | 44. Bearing |
| 9. 3rd drive gear | 21. Spring | 33. Lock washer | 45. Spacer |
| 10. 4th drive gear | 22. Sliding stopper | 34. 3rd driven gear | 46. Oil seal |
| 11. Circlip | 23. Stopper | 35. Bushing | |
| 12. Spacer (32 × 36 × 13.4) | 24. Spring guide | 36. Washer | |

INSPECTION

Shift fork — Groove clearance

- Using a thickness gauge, measure the fork groove clearance. If it exceeds the limit, check the amount of wear on both gear and shift fork using vernier calipers, and replace either one that has greater wear.

Shift fork-Groove clearance

Standard	Limit
0.4 — 0.6 mm (0.016 — 0.024 in)	0.8 mm (0.031 in)

Shift fork groove width

Standard	5.45 — 5.55 mm (0.215 — 0.219 in)

Shift fork thickness

Standard	4.95 — 5.05 mm (0.195 — 0.199 in)

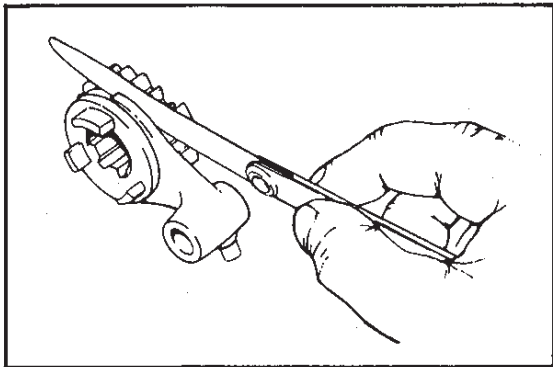

REMOVAL

- Remove the bearing and spacer, compress the spring with the special tool ①, and remove two stoppers ②.

Dog cam stopper set tool	09924-44510
--------------------------	-------------

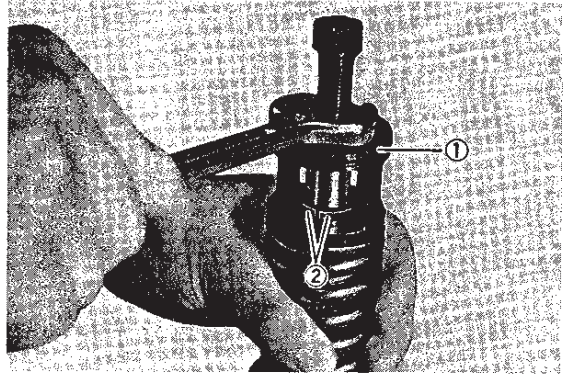

INSTALLATION

Installation is carried out in the reverse order of removal.

COUNTERSHAFT AND GEARS

NOTE:

- Before installing the shafts and gears, wash them in a cleaning solvent.
 - Before mounting the gears on the outer shaft, apply the engine oil to the gear bore.
- For gear installation, refer to page 48. (Be sure that the gears, spacers, washers and circlips are correctly mounted facing in the correct direction.)
 - Always use new circlips.
 - Align the oil hole in the spacer with that in the outer counter shaft, and mount the spacer on the shaft.

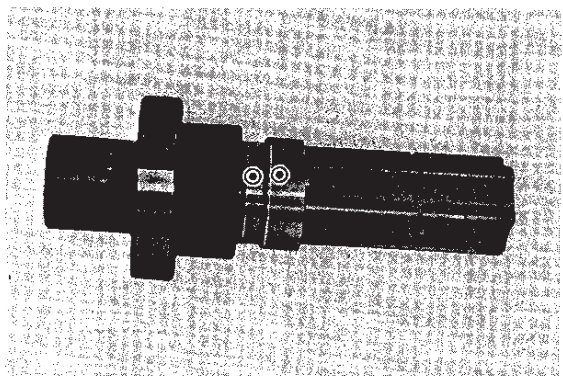

- Install the locating washer to the spacer dogs.
- Take special care so that the circlip is correctly installed, fit it to the side where the thrust is as shown in the figure.

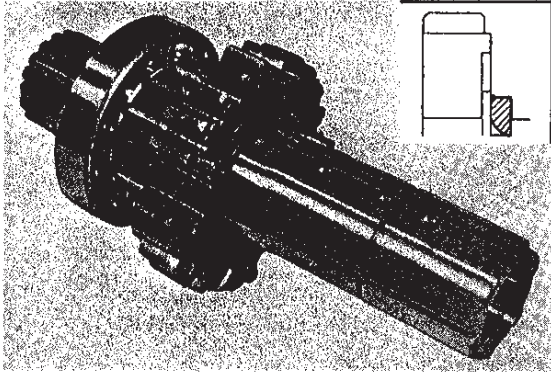

- Before mounting the 5th drive gear on the outer shaft, align the oil hole in the spacer ① with that in the outer shaft.

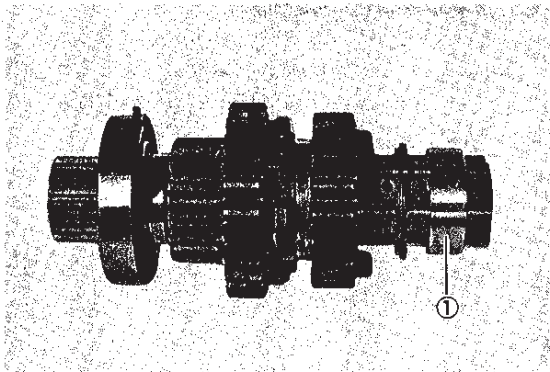

- When installing the 5th drive gear spacer on the outer shaft, be sure that the spacer faces in the correct direction.

NOTE:

- Sparingly apply **SUZUKI MOLY PASTE (99000-25140)** to the area of the outer counter shaft bore, 20 to 30 mm (0.8 – 1.2 in) from each end of the shaft. Oil bearing surfaces on inner countershaft.

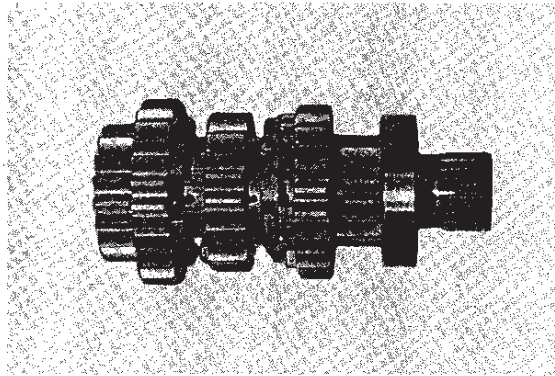

NOTE:

- Mount the 2nd drive gear on the outer counter shaft, apply **SUZUKI MOLY PASTE (99000-25140)** to both surfaces of the washer sparingly, and install the washer.

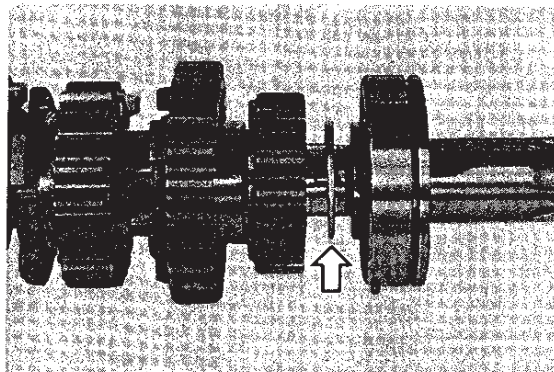

- Now install inner shaft into outer shaft.
- Mount the output cam dog on the outer counter shaft. Align the cut on the cam dog with the oil hole in the counter shaft.

Next, apply **SUZUKI MOLY PASTE (99000-25140)** to the splines of the input cam dog, and mount it on the inner counter shaft.

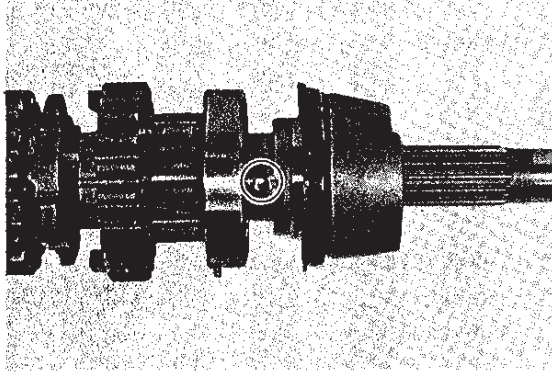

- Mount the spring, spring guide, and sliding stopper on the inner counter shaft, and compress the spring with the special tool ①, and install the two stoppers.

Dog cam stopper set tool	09924-44510
--------------------------	-------------

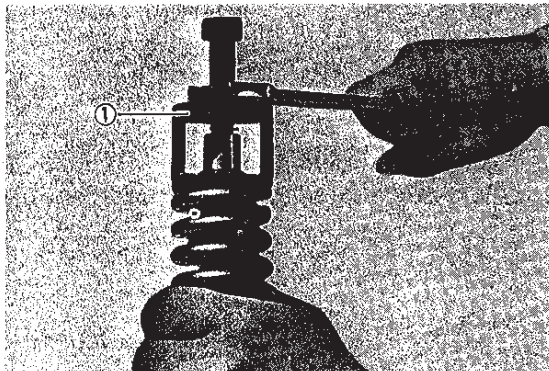

DRIVE SHAFT AND GEARS

NOTE:

- Before installing the shaft and gears, wash them in a cleaning solvent.
 - Before mounting the gears on the drive shaft, apply the engine oil to the gear bore.
- For gear installation, refer to page 48.
(Be sure that the gears, spacer, washers and circlips are correctly mounted facing in the correct direction.)
 - Always use new circlips.

NOTE:

Order of mounting of spacer ②, washer ③, circlip ④, 3rd driven gear ⑤, lock washer ⑥, and washer ⑦.

- Mount the circlip ④ and washer ③ on the drive shaft, in that order.
Temporarily position the circlip beyond the groove.

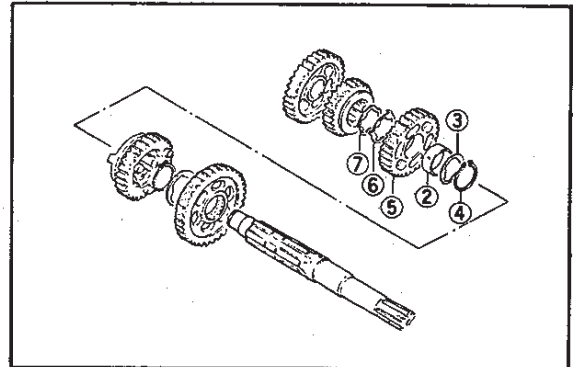

- Align the hole in the spacer with the oil hole in the drive shaft, and install the 3rd driven gear.

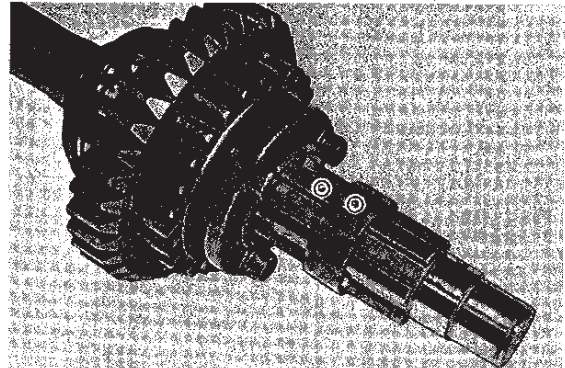

- Mount the lock washer and washer, on the drive shaft, in that order, and by turning the washer in or out, align the lock washer tongue with the cut on the washer.

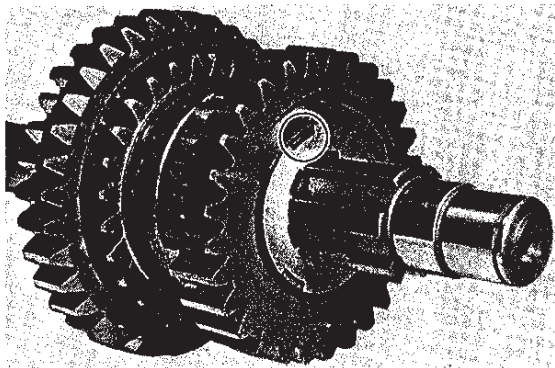

- Fit the circlip in the groove on the driveshaft, using the special tool

Snap ring pliers	09900-06106
------------------	-------------

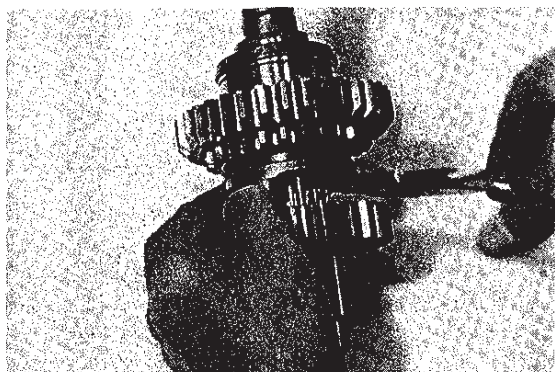

- Take special care so that the circlip is correctly installed. Fit it to the side where the thrust is as shown in the figure.

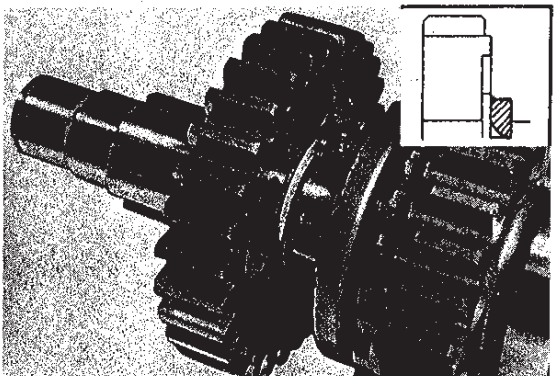

NOTES ON INSTALLATION OF TRANSMISSION GEARS AND CRANKSHAFT IN CRANKCASE

- Thoroughly wash the upper crankcase and the lower crankcase with solvent to remove any sealing compound.
- Firmly insert crankshaft locating "pins" ①, transmission gear locating "C" rings ② for bearings on both sides and locating pin ③.

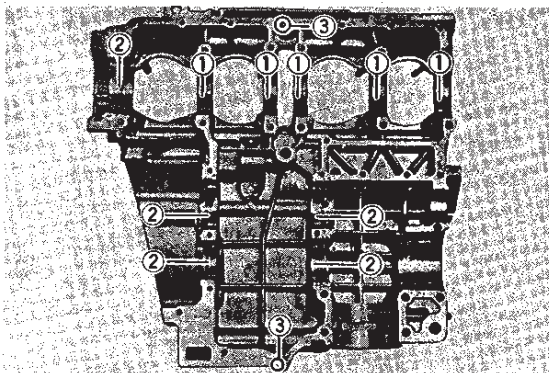

- Mount crankshaft and transmission shaft assemblies on the upper case. At this time firmly fit the bearing races onto the locating pins with punch mark stamped on the circumference of the bearings directed upwards.

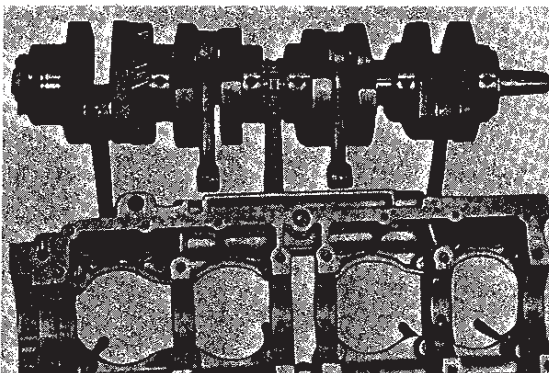

- Use the "C" rings and bearings stopper pins to position the bearings as shown in the photo.

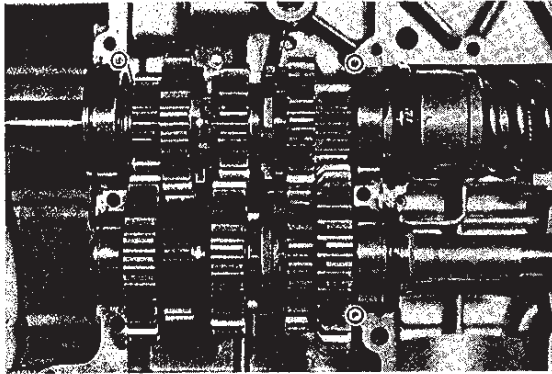

- Insert gear shifting cam into the lower crankcase. Confirm the neutral position of gear shifting cam, mount cam stopper, spring and cam stopper holder and fasten the cam stopper holder.

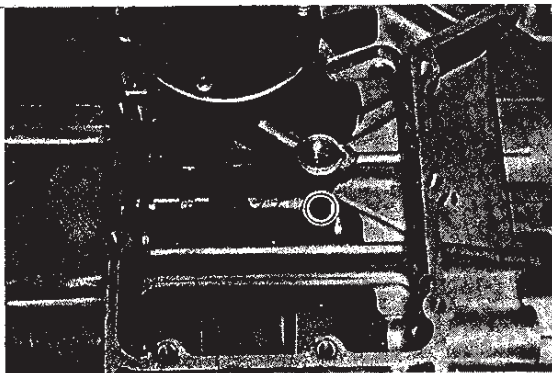

- Insert gear shifting fork shaft from the right side and mount gear shifting fork and cam stopper as shown in the photo. At this time, pay attention to the direction of the gear shifting fork.

- ① Gear shifting fork for 3rd drive gear.
- ② Gear shifting forks for 4th and 5th driven gears.
- ③ Cam stopper.

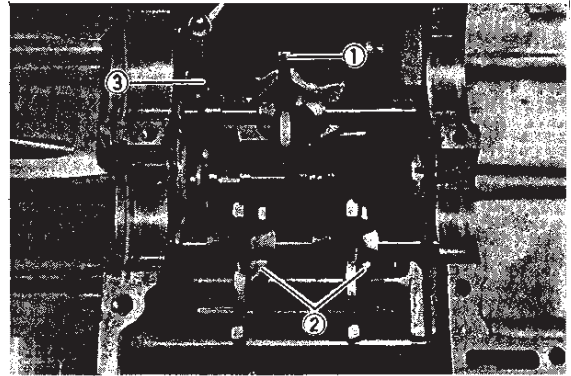

- Apply engine oil to gear shifting fork and gear shifting cam.
- Completely wipe off oil on the mating surface of lower crankcase and apply sealing compound (SUZUKI BOND No. 1201: 99104-31100) uniformly to the mating surface.

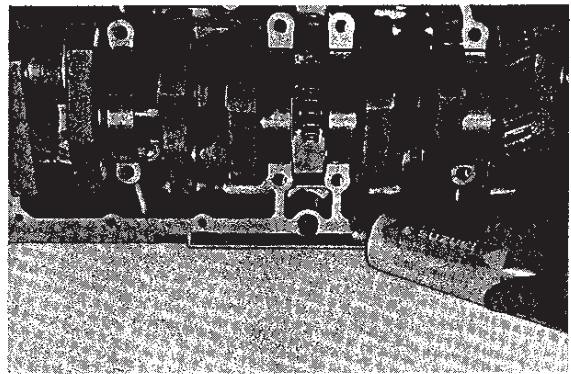

- Place the lower crankcase on the upper crankcase housing the transmission gears and crankshaft. Align shift forks into gears.
- Fasten together the upper and lower crankcase halves using the crankcase fastening bolts.

The lower crankcase fastening bolts must be tightened securely in the ascending order of the numbers embossed on the crankcase.

- 6 mm bolt 9 pcs.
- 8 mm bolt 12 pcs.

Tightening torque for 6 mm bolts	6 – 10 N·m 0.6 – 1.0 kg·m 4.5 – 7.0 lb·ft
Tightening torque for 8 mm bolts	18 – 22 N·m 1.8 – 2.2 kg·m 13.0 – 16.0 lb·ft

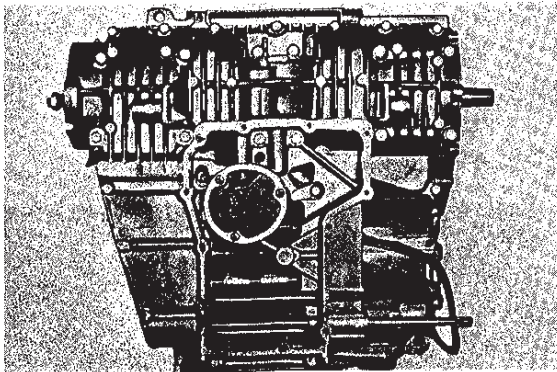

NOTE:

- *When the secondary bevel gear is installed, the offset at the mating surfaces of the crankcase halves, upper and lower, should be 0.1 mm or less.*
- *Thoroughly wipe off any overflow of the sealing compound applied to the mating surfaces of crankcase before installing the secondary bevel gear assemblies. Take special care not to scratch inner surfaces of the crankcase.*
- *The shape of each gear shifting pawl is different. Mount the one with the narrower width on the gear shifting cam side.*

- Tighten the oil pan bolts.
 - Turn the crankcase over so that the cylinder studs are up and tighten the upper crankcase bolts.
- 6 mm bolt 12 pcs.
 - 8 mm bolt 5 pcs.

Tightening torque for 6 mm bolts	6 – 10 N·m 0.6 – 1.0 kg·m 4.5 – 7.0 lb·ft
Tightening torque for 8 mm bolts	18 – 22 N·m 1.8 – 2.2 kg·m 13.0 – 16.0 lb·ft

LUBRICATION SYSTEM

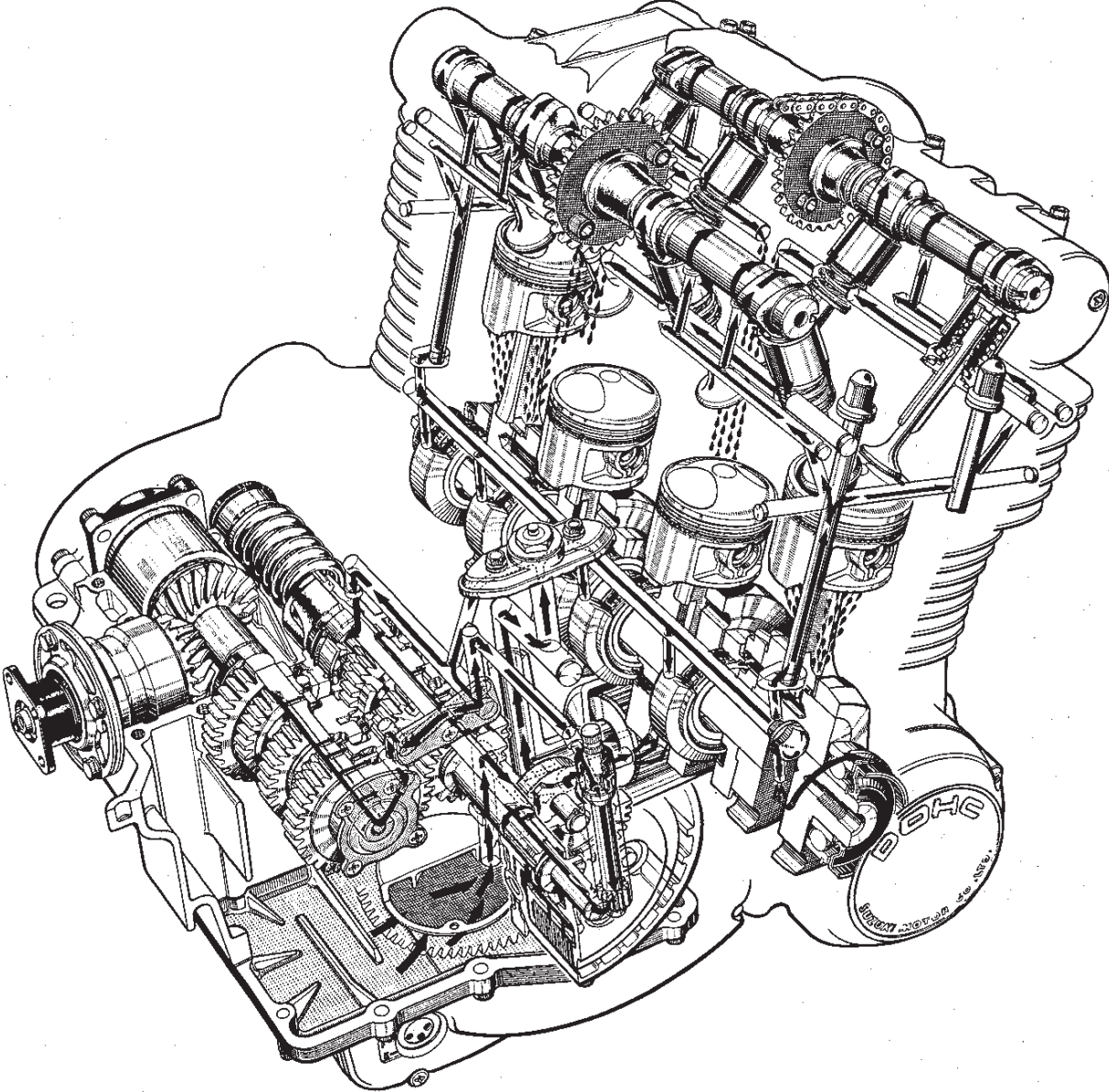

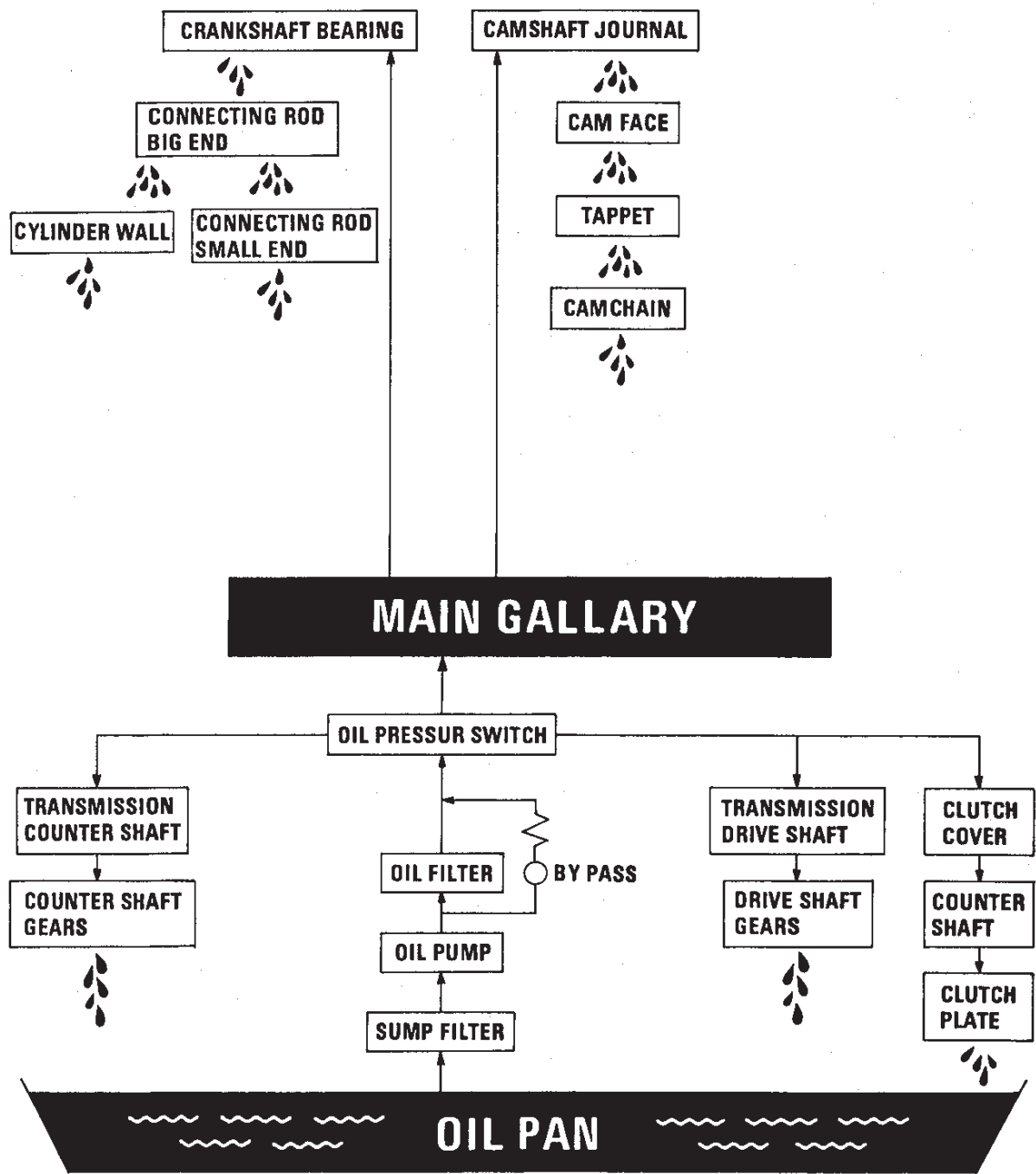

SHAFT DRIVE

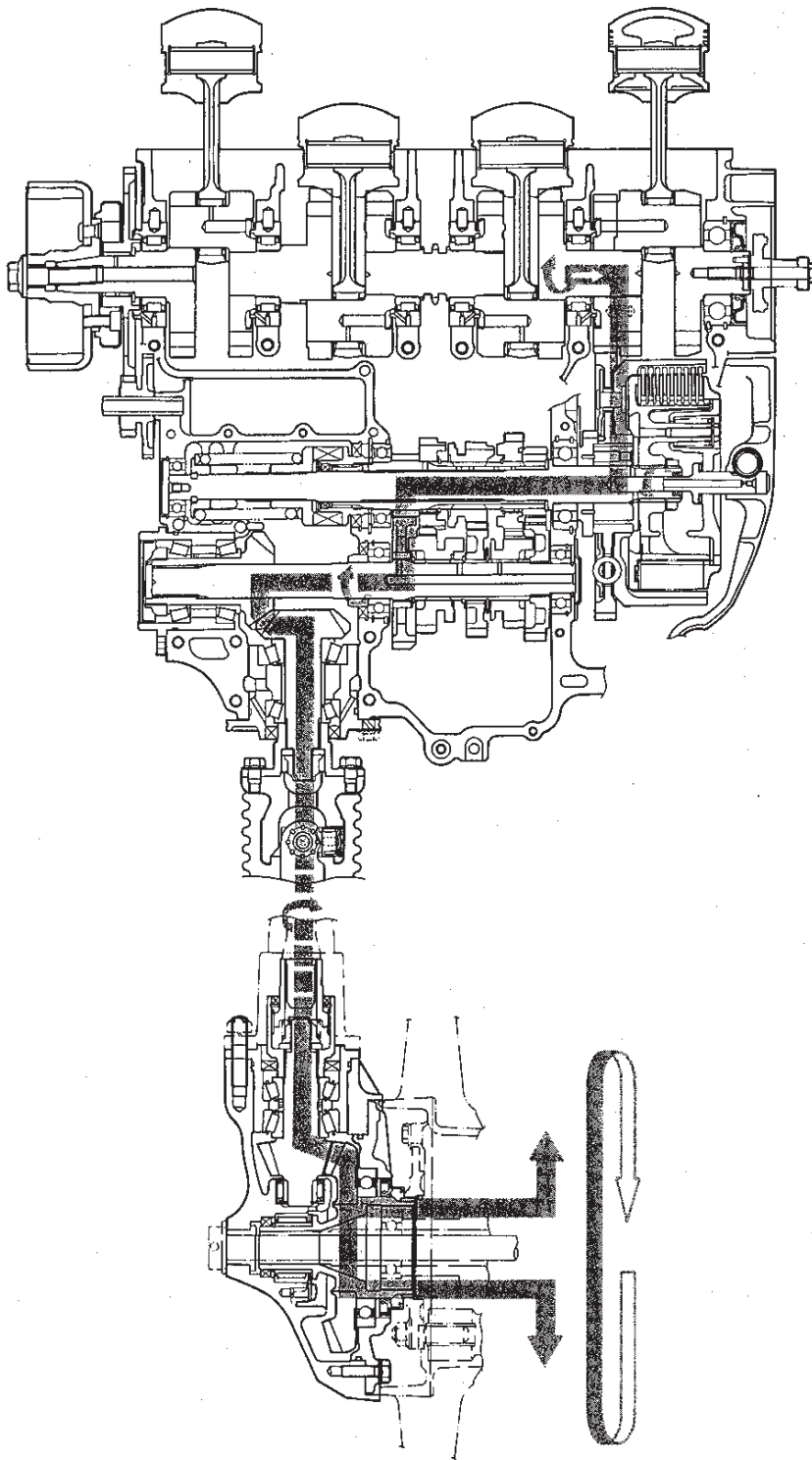

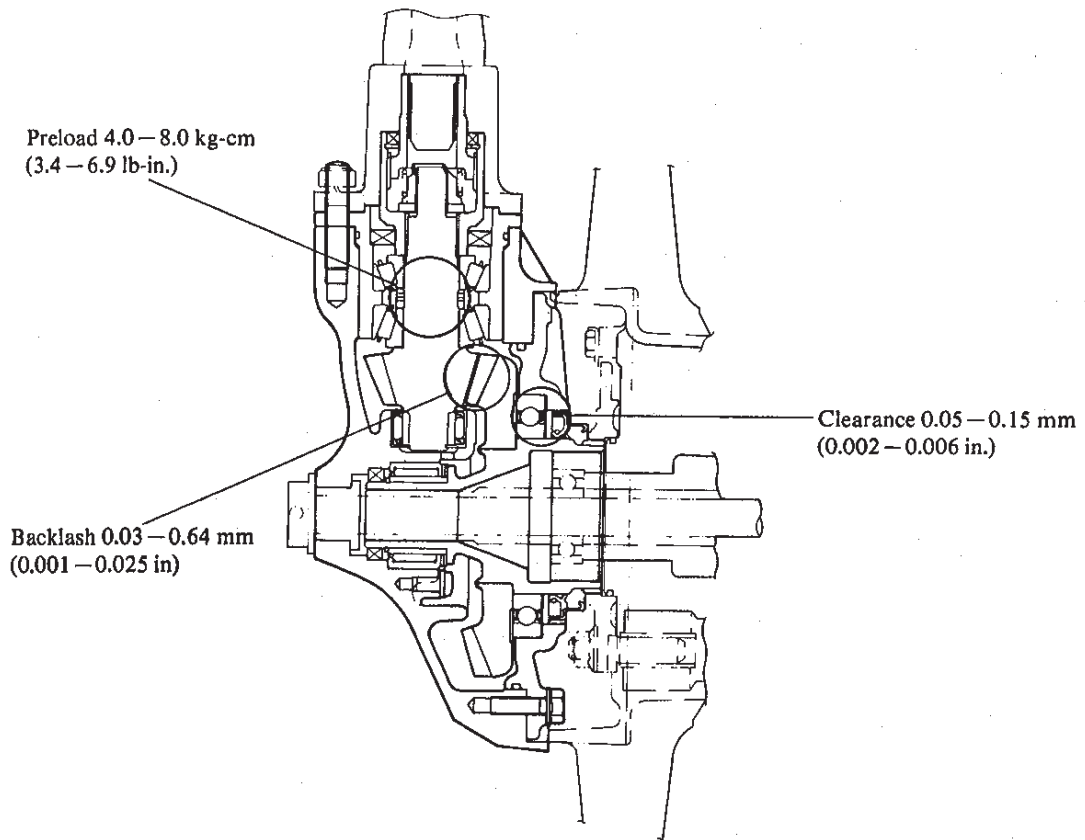
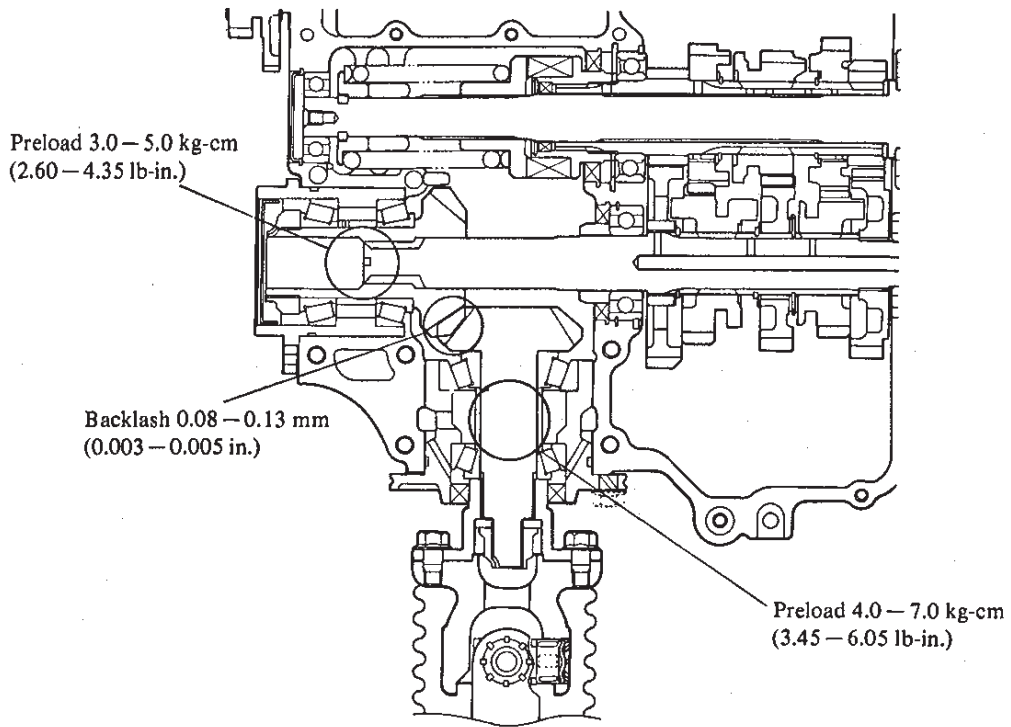

FINAL DRIVE BEVEL GEAR ASSEMBLY

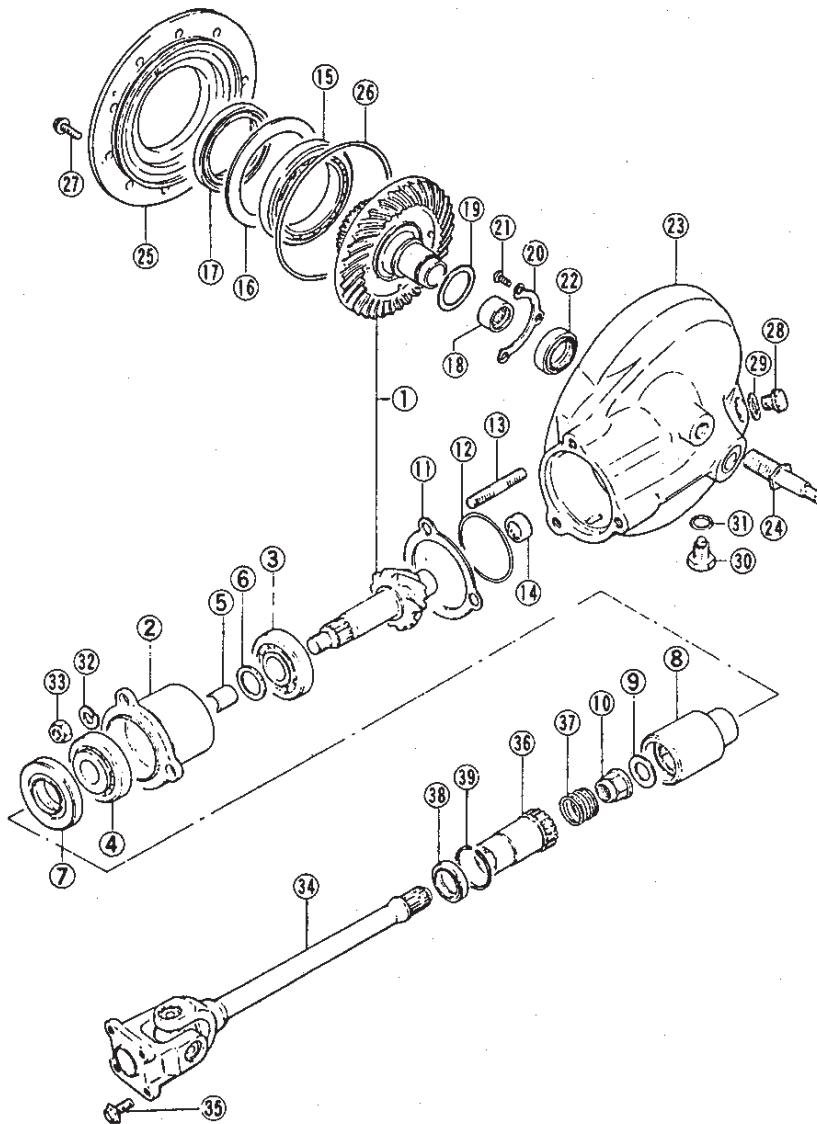

- | | |
|-------------------------|------------------------------|
| 1. Final bevel gear set | 21. Screw |
| 2. Drive gear housing | 22. Oil seal |
| 3. Bearing | 23. Final gear case |
| 4. Bearing | 24. Stud bolt |
| 5. Spacer | 25. Final gear bearing case |
| 6. Shim | 26. O ring |
| 7. Oil seal | 27. Bolt |
| 8. Drive gear coupling | 28. Oil filler plug |
| 9. Washer | 29. Gasket |
| 10. Nut | 30. Oil drain plug |
| 11. Shim | 31. Gasket |
| 12. O ring | 32. Lock washer |
| 13. Stud bolt | 33. Nut |
| 14. Bearing | 34. Propeller shaft |
| 15. Bearing | 35. Bolt |
| 16. Shim | 36. Propeller shaft coupling |
| 17. Oil seal | 37. Spring |
| 18. Bearing | 38. Oil seal |
| 19. Shim | 39. Circlip |
| 20. Bearing holder | |

	Tightening torque		
	N·m	kg·m	lb·ft
⑩	90 - 110	9.0 - 11.0	65.0 - 79.5
⑳	8 - 10	0.8 - 1.0	6.0 - 7.0
㉔	90 - 110	9.0 - 11.0	65.0 - 79.5
㉗	20 - 26	2.0 - 2.6	14.5 - 19.0
㉘	20 - 30	2.0 - 3.0	14.5 - 21.5
㉚	20 - 30	2.0 - 3.0	14.5 - 21.5
㉛	35 - 45	3.5 - 4.5	22.5 - 32.5
㉝	25 - 30	2.5 - 3.0	18.0 - 21.5

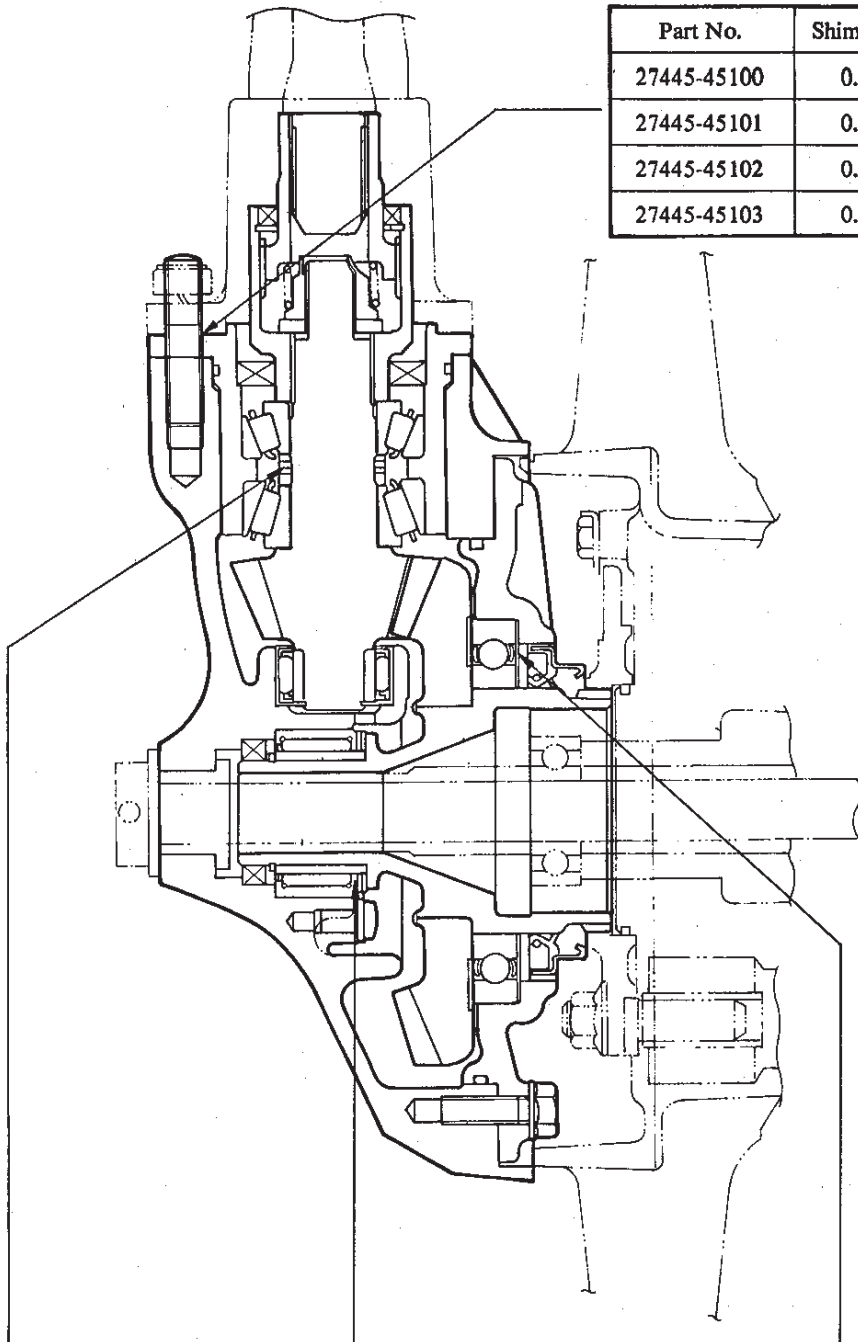

Part No.	Shim thickness
27445-45100	0.15 mm
27445-45101	0.30 mm
27445-45102	0.35 mm
27445-45103	0.40 mm

Part No.	Shim thickness
09181-25006	1.60 mm
09181-25007	1.62 mm
09181-25008	1.64 mm
09181-25009	1.66 mm
09181-25010	1.68 mm
09181-25011	1.70 mm
09181-25012	1.80 mm
09181-25013	1.90 mm
09181-25014	2.00 mm

Part No.	Shim thickness
27326-45100	1.25 mm
27326-45101	1.20 mm
27326-45102	1.05 mm
27326-45103	1.10 mm
27326-45104	1.35 mm

Part No.	Shim thickness
27327-45100	0.35 mm
27327-45102	0.40 mm
27327-45103	0.50 mm
27327-45104	0.60 mm

FINAL GEAR CASE BREATHER CIRCUIT

AIR AND GEAR OIL FLOW IN FINAL GEAR CASE BREATHER CIRCUIT

Breather circuit

The GS1000G final gear case breather circuit (passage) consists of the final gear case and final gear bearing case, and air/oil mixed gas flows through the following routes:

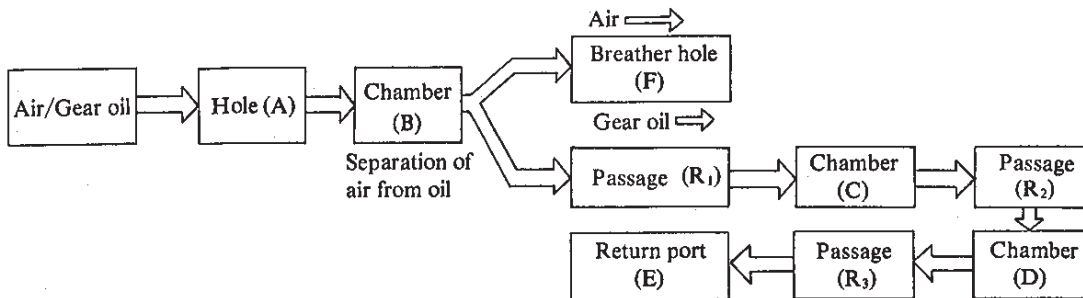
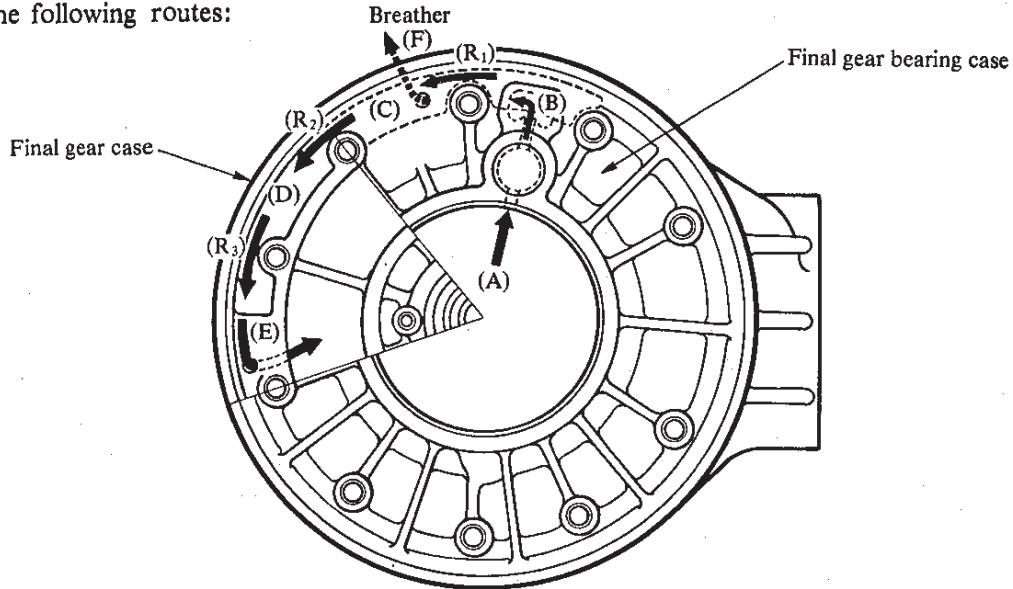

Air passage

When the air pressure in the final gear case becomes higher than atmospheric pressure both air and oil flow in the following passages.

- Air flows from hole (A) to chamber (B) and passes through the gap between rib (R₁) and bearing case to the atmosphere through the breather hole (F).

Oil passage

When the final gear case pressure rises abruptly or when the gear case oil level changes during cornering, the gear oil may sometime flows out into the air passage.

- In this case, the gear oil, which has flown into hole (A), goes into chamber (B), where the oil is separated from the air.
- Then, the air flows through the gap between rib (R₁) and bearing case and goes out through the breather.
- On the other hand, the gear oil, when the gear case pressure is higher than atmospheric pressure, flows through the gaps between ribs, (R₁), (R₂) and (R₃) and bearing case and returns to the gear case from gear oil return port (E).

FINAL DRIVE BEVEL GEAR ASSEMBLY

REMOVAL AND DISASSEMBLY

NOTE:

Be sure to retain all adjusting shims for reassembly.

- Place an oil pan under the final drive bevel gear assembly, remove the drain plug and drain the oil.
- Remove the rear wheel assembly.
- Remove three nuts attaching the final drive housing to the swing arm, and move the housing to the rear to detach it from the swing arm.
- Remove ten final gear bearing case bolts.

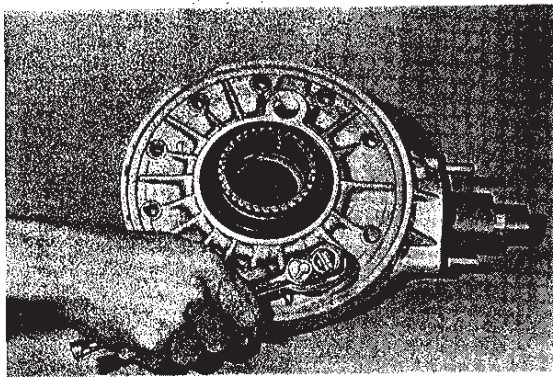

- To remove the final gear bearing cover from the housing, use two 6 mm screws; screw them into the holes provided and draw the cover off evenly.

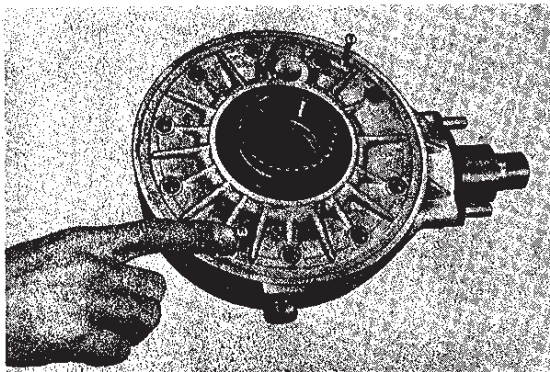

- Using special tools ① and ②, remove the oil seal from the final gear bearing case.

①	Bearing and oil seal handle	09924-74510
②	Oil seal installer and remover	09924-74520

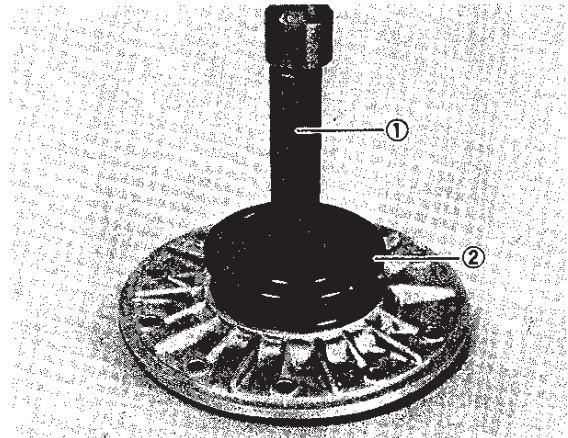

③	Final driven gear bearing installer and remover	09924-74570
---	---	-------------

- Using special tool ③, remove the ball bearing from the driven gear.

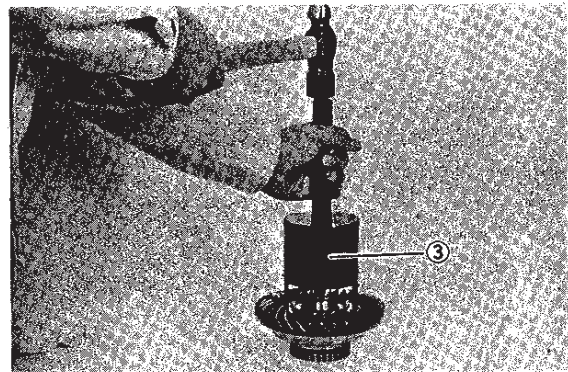

- Remove the three screws and bearing retainer, and shims from the final gear case.

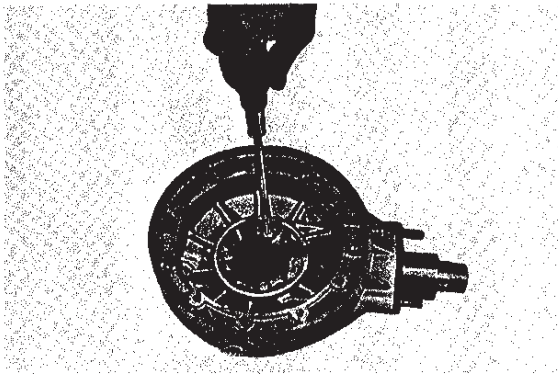

- Remove the final drive gear housing from the final gear case.
- Remove the oil seal ①, circlip ②, propeller shaft coupling ③, and spring ④ from the final drive gear coupling.

⑤	Snap ring plier	09900-06108
---	-----------------	-------------

NOTE:

To remove the circlip ②, it will be necessary to push the propeller shaft coupling inwards, to remove spring pressure from the circlip.

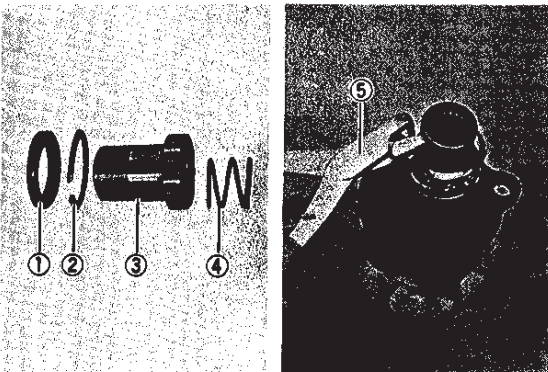

- Straighten the bent portion of the final drive gear nut. Use special tool ⑥ to hold the coupling, and remove the nut.

⑥	Final drive gear coupling holder	09924-64510
---	----------------------------------	-------------

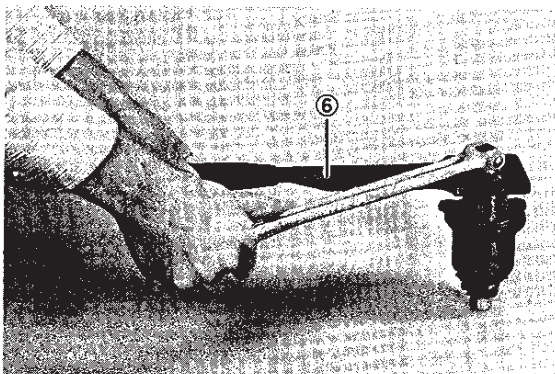

- Remove the washer and coupling, and tap the drive gear shaft with a plastic hammer to remove it from housing. Do not lose the shims and spacer on the final drive gear shaft.

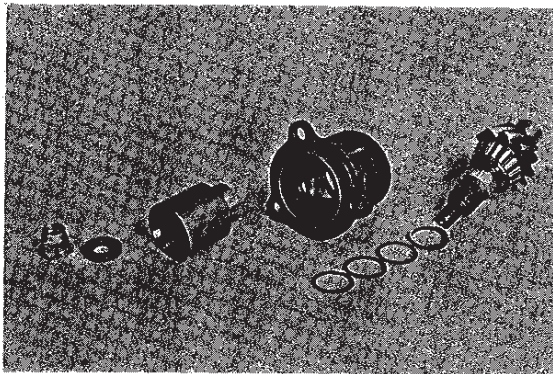

- To remove the inner bearing race from the drive gear shaft, use special tool ⑦.

⑦	Bearing inner race remover	09941-84510
---	----------------------------	-------------

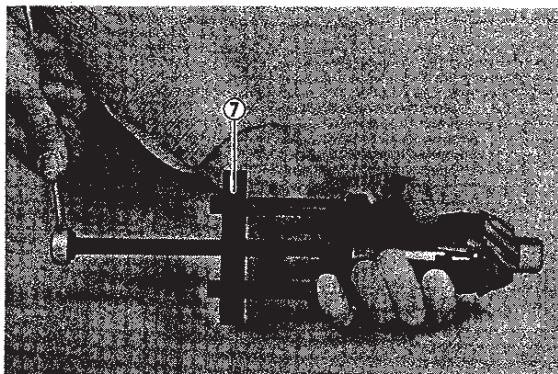

- To remove the oil seal from the housing, use special tools ① and ②.

①	Bearing and oil seal remover	09941-64510
②	Rotor remover shaft set	09930-30102

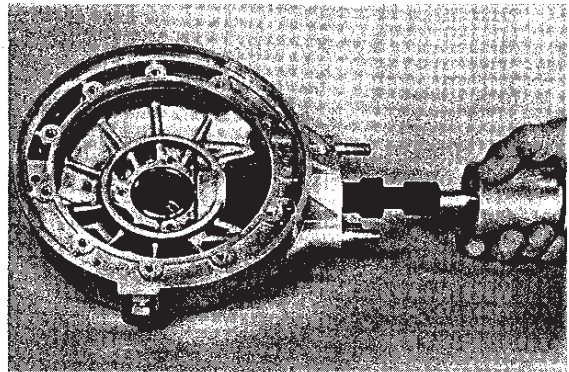
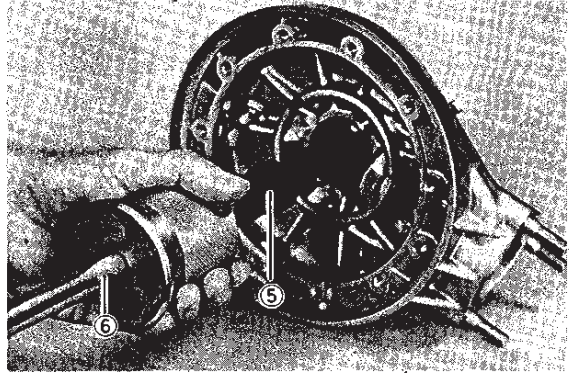
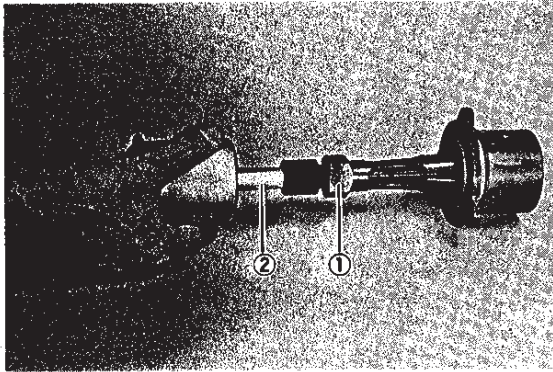

- To remove the outer bearing races from the housing, use special tools ③ and ④ and a hammer.

③	Bearing Outer Race Remover	09941-54911
④	Bearing Installer	09913-84510

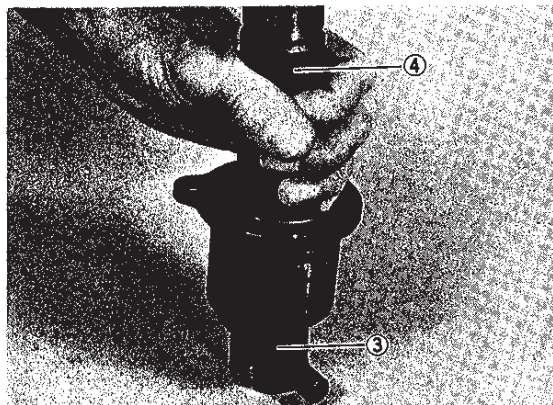

- To remove the final gear case oil seal, use special tools ⑤ and ⑥.

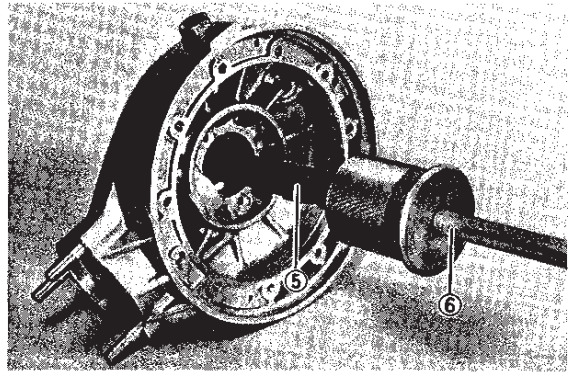

- To remove the two needle roller bearings from the final gear case, use special tools ⑤ and ⑥.

⑤	Bearing and oil seal remover	09941-64510
⑥	Rotor remover shaft set	09930-30102

- If replacing the final gear case, remove the three drive housing studs, and shock absorber mounting stud.

INSPECTION AND REASSEMBLY

NOTE:

Before reassembly, thoroughly clean all parts in cleaning solvent.

NOTE:

It will be helpful to have a selection of all shims available for clearancing operations.

- To install the outer bearing races into the drive gear housing, use special tool ①.

①	Bearing installer set	09924-84510
---	-----------------------	-------------

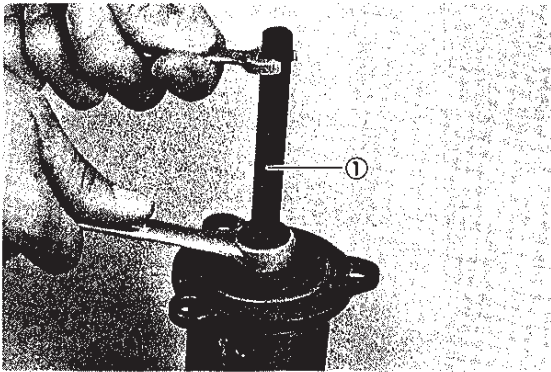

- To install the inner bearing race onto the final drive gear shaft, use special tool ②.

CAUTION:

When replacing the final drive gear, replace the driven gear also, as they must be replaced together.

②	Bearing installer set	09913-84510
---	-----------------------	-------------

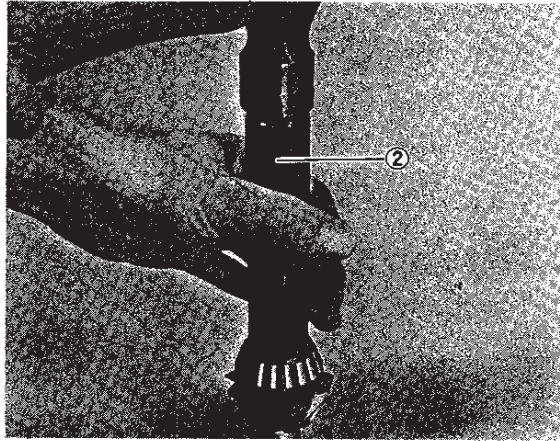

- Install the spacer and shims removed from the old final drive gear on the new gear. Install gear into housing.

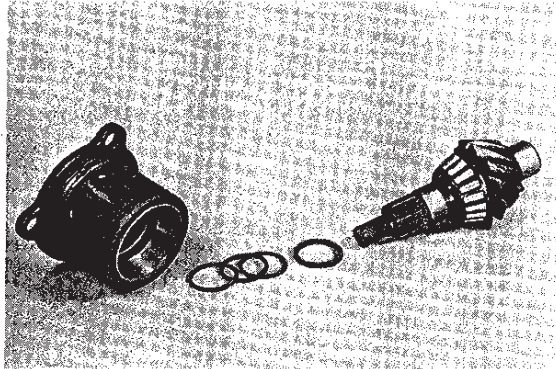

- Install the other inner bearing race, the washer and final drive gear nut, and tighten to specification, using special tool ③.

NOTE:

Always use a new nut.

NOTE:

Coat the bearings with Hypoid gear oil.

NOTE:

No oil seal is installed at this point. Oil seal is installed after bearing preload is correct.

Nut tightening torque	90 — 110 N•m
	9.0 — 11.0 kg•m
	65.0 — 79.5 lb•ft

③	Final drive gear coupling holder	09924-64510
---	----------------------------------	-------------

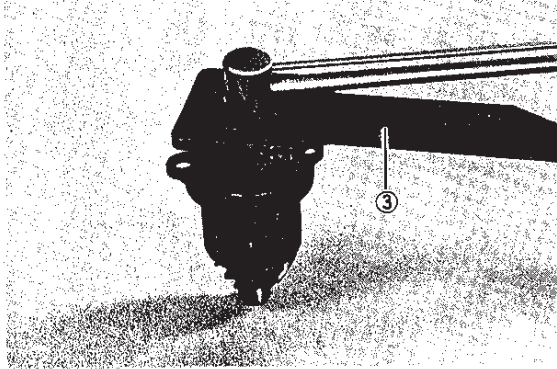

FINAL DRIVE GEAR PRELOAD ADJUSTMENT

- After tightening the final drive gear nut to specification, measure the bearing preload using torque wrench.

NOTE:

Rotate the gear several turns in both directions to seat the bearings.

Preload torque	40 — 80 N•cm
	4.0 — 8.0 kg•cm
	3.4 — 6.9 lb•in

Torque wrench	09900-21107
---------------	-------------

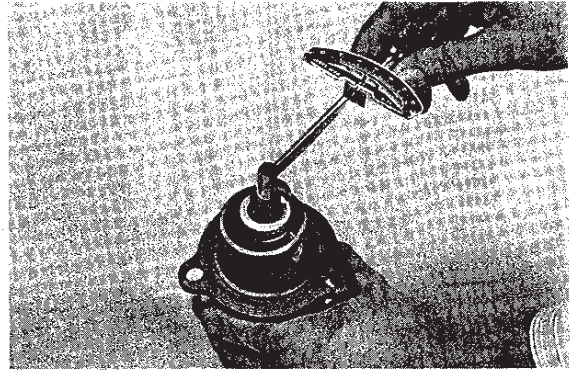

- If the preload measured is not correct. (4.0-8.0 kg•cm) remove the final drive gear and change the shims according to the following chart:

Preload	Shim
Under 4 kg•cm	Decrease shim thickness
40 — 80 N•cm 4.0 — 8.0 kg•cm 3.4 — 6.9 lb•ft	Correct
Over 8 kg•cm	Increase shim thickness

- Re-torque the final drive gear nut to specification, and re-check the preload measurement until it is correct.

List of Shims

Part No.	Shim thickness
09181-25006	1.60 mm
09181-25007	1.62 mm
09181-25008	1.64 mm
09181-25009	1.66 mm
09181-25010	1.68 mm
09181-25011	1.70 mm
09181-25012	1.80 mm
09181-25013	1.90 mm
09181-25014	2.00 mm

- Once the bearing preload is correct, remove the nut, washer and coupling, and remove the final drive gear from the housing. Using special tools ① and ②, install a new oil seal into the housing.

①	Bearing and oil seal handle	09924-74510
②	Final drive bevel gear housing oil seal installer	09924-74560

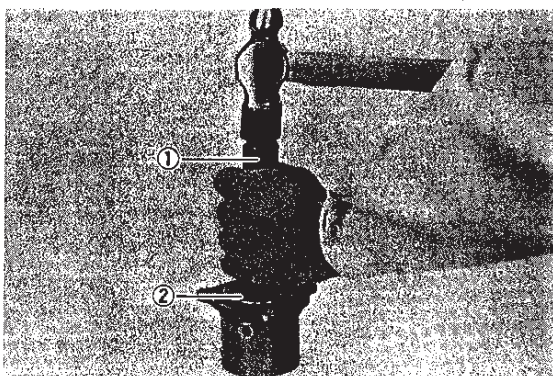

- Liberally coat the bearings with Hypoid gear oil and reinstall the final drive gear into the housing.

- Make sure the final drive gear threads are free of oil. Put a small amount of THREAD LOCK SUPER "1361A" on the threads, install the drive gear coupling, washer and nut, and torque to specification.

Thread lock super "1361A"	99104-32020
---------------------------	-------------

③	Final drive gear coupling holder	09924-64510
---	----------------------------------	-------------

Nut tightening torque	90 — 110 N·m
	9.0 — 11.0 kg·m
	65.0 — 79.5 lb·ft

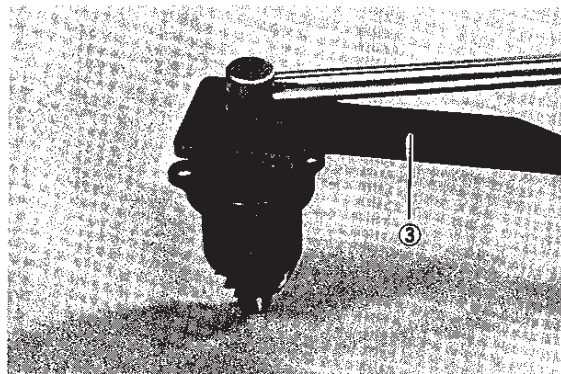

- After tightening the nut to specification, bend the collar of the nut over into the notch in the final drive gear shaft.

FINAL DRIVEN GAER ASSEMBLY

- To install the final gear case oil seal, use special tools ① and ②.

①	Oil Seal Installer	09924-74550
②	Handle	09924-74510

NOTE:

The oil seal is correctly installed when the lip spring is on the driven gear side.

NOTE:

Always use a new oil seal.

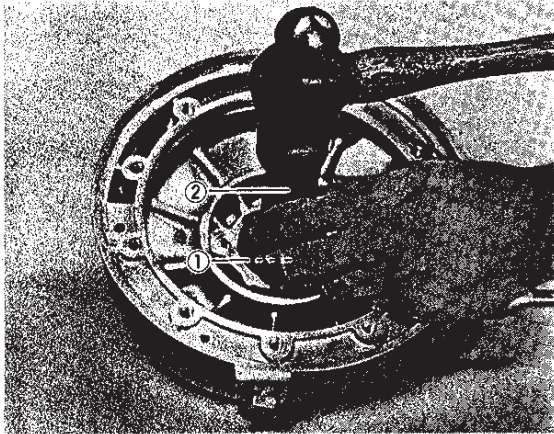

- Use special tools ③ and ④ to install the needle bearing for the driven gear.

CAUTION:

The bearing case has a stamped mark on one end, which must face inside.

③	Bearing Installer	09913-84510
④	Final Gear Case Bearing Installer	09924-94510

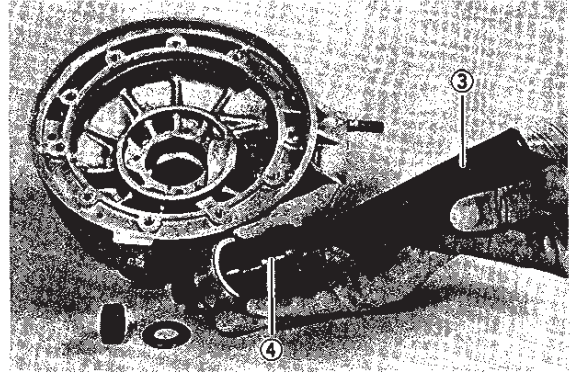

- Install the needle roller bearing for the final drive gear into the final gear case using special tools ⑤, ⑥ and ⑦.

⑤	Bearing and oil seal installer handle	09924-74510
⑥	Bearing installer	09924-74530
⑦	Pilot	09924-74540

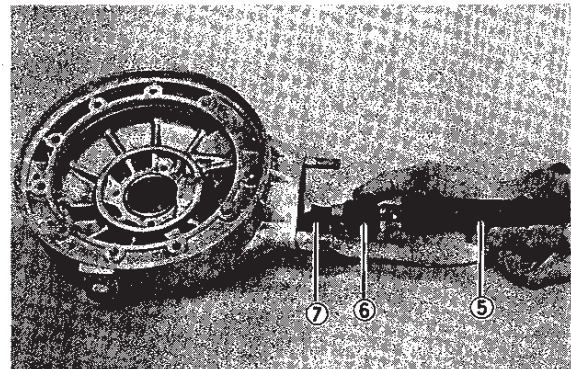

- Install the driven gear needle bearing retainer plate. Use THREADLOCK "1363C" on the screws, and tighten to specification.

99104-32050	Thread Lock "1363C"
-------------	---------------------

Screw tightening torque	8.0 — 10.0 N·m
	0.8 — 1.0 kg·m
	6.0 — 7.5 lb·ft

- Install the ball bearing onto the final driven gear, using special tool ①.

①	Final driven gear bearing installer	09924-74570
---	-------------------------------------	-------------

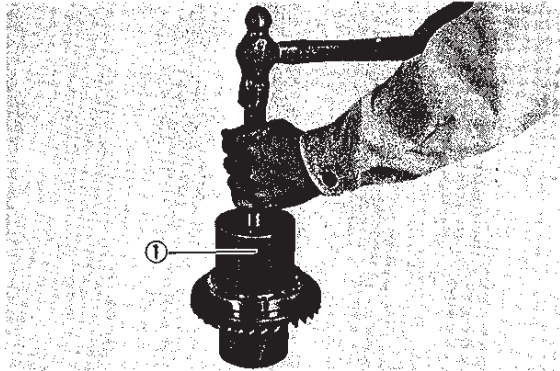

- Place the final driven gear shims on the driven gear needle bearing, oil the bearing with Hypoid gear oil, and install the driven gear complete into the final gear case.

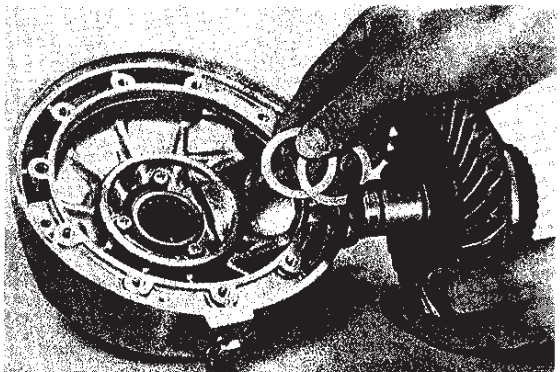

- Oil the final driven gear ball bearing with Hypoid gear oil, place the shims removed during disassembly on the bearing, and install the final driven gear bearing cover, without oil seal. Install the ten bolts and tighten to specification.

Final Gear Bearing Cover Bolt Torque	20 – 26 N·m
	2.0 – 2.6 kg·m
	14.5 – 19.0 lb·ft

FINAL GEAR BEARING COVER SHIM ADJUSTMENT

- Using a thickness gauge, measure the clearance between the shims and the bearing cover. If not within specification, the shims must be changed.

Final gear bearing cover shim clearance	0.05 – 0.15 mm (0.002 – 0.006 in)
---	--------------------------------------

List of Shims

Part Number	Thickness
27327-45100	0.35 mm
27327-45102	0.40 mm
27327-45103	0.50 mm
27327-45104	0.60 mm

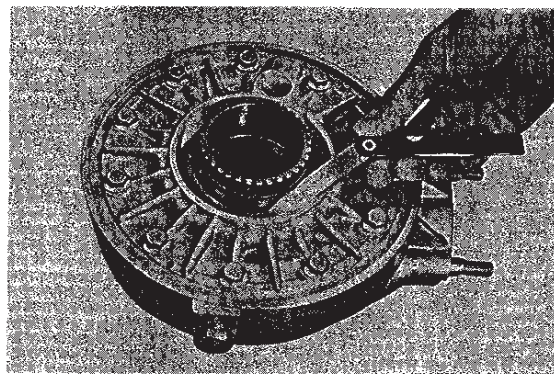

BACKLASH MEASUREMENT

- Using the shims removed during disassembly, install the final drive gear housing, without o-ring, into the final gear case and remove the final gear bearing case oil seal. Tighten the nuts and bolts to specification.

①	Final Drive Gear Housing Nut Torque	35 – 45 N·m 3.5 – 4.5 kg·m 25.5 – 32.5 lb·ft
②	Final Gear Bearing Case bolt	20 – 26 N·m 2.0 – 2.6 kg·m 14.5 – 19.0 lb·ft

- Install the backlash measuring tool on the drive gear coupling, and set-up a dial gauge as shown below.

Backlash Measuring Tool (A) (27 – 50φ)	09924-34510
---	-------------

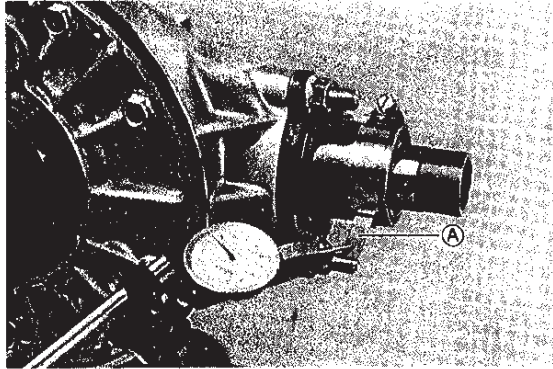

- Adjust the dial gauge so that it touches the backlash measuring tool arm at the mark; hold the final driven gear securely, and turn the final drive gear coupling slightly in each direction, reading the total backlash on the dial gauge.

Final Gear Backlash	0.03 – 0.64 mm (0.001 – 0.025 in)
---------------------	--------------------------------------

NOTE:

When measuring the backlash, measure not only one gear tooth but also several teeth after rountaiting the drive gear clockwise or counter clockwise completly.

If the backlash is not correct, adjust the all measured backlash within the specified value.

- Remove shims from final gear cover and final gear case, and measure total thickness.
- In order not to change the clearance between the final gear cover and final driven gear bearing, the total thickness of the shims installed after a change is made must equal the original total thickness of shims.
- If backlash is too large:
 - a) Install a thinner shim pack between final driven gear and final gear case.

- b) Increase thickness of shims between final gear cover and bearing by an amount equal to the decrease above.

- If backlash is too small:
 - a) Install a thicker shim pack between final driven gear and final gear case.
 - b) Decrease thickness of shims between final gear cover and bearing by an amount equal to the increase above.

EXAMPLE:

Final gear to case shims;

$$1.35 \text{ mm} + 1.05 \text{ mm} = 2.40 \text{ mm}$$

Final gear cover to bearing shims;

$$0.50 \text{ mm} + 0.40 \text{ mm} = 0.90 \text{ mm}$$

$$\text{Original total measurement} = 3.30 \text{ mm}$$

Backlash too large:

Final gear to case shims;

$$1.30 \text{ mm} + 1.05 \text{ mm} = 2.35 \text{ mm}$$

Final gear cover to bearing, shims;

$$0.60 \text{ mm} + 0.35 \text{ mm} = 0.95 \text{ mm}$$

$$3.30 \text{ mm}$$

Backlash too small:

Final gear to case shims;

$$1.40 \text{ mm} + 1.05 \text{ mm} = 2.45 \text{ mm}$$

Final gear cover to bearing shims;

$$0.50 \text{ mm} + 0.35 \text{ mm} = 0.85 \text{ mm}$$

$$3.30 \text{ mm}$$

List of Shims - Final Gear to Case

Part Number	Thickness
27326-45100	1.25 mm
27326-45101	1.20 mm
27326-45102	1.05 mm
27326-45103	1.10 mm
27326-45104	1.35 mm

List of Shims - Final Gear Cover to Bearing

Part Number	Thickness
27327-45100	0.35 mm
27327-45102	0.40 mm
27327-45103	0.50 mm
27327-45104	0.60 mm

TOOTH CONTACT ADJUSTMENT

- After backlash adjustment is carried out, the tooth contact must be checked.
- Remove the 10 bolts from the final gear cover, and remove the cover, using the screws from the contact breaker cover (see page 59). Do not misplace the shims. Remove the driven gear.
- Clean and de-grease several teeth on the final driven gear. Coat these teeth with machinist's dye (usually available from parts houses) or paste, preferably of a light color.
- Re-install the driven gear with shims in place, positioning the coated teeth so they are centered on the final drive gear.
- Re-install the final gear cover and bolts, and tighten to specification.

Final Gear Cover Bolt Torque	20 – 26 N•m 2.0 – 2.6 kg•m 14.5 – 19.0 lb•ft
------------------------------	--

- Using a socket and handle on the final drive gear coupling nut, rotate the final drive gear several turns in each direction, while loading the final driven gear. This will provide a contact pattern on the coated teeth of the driven gear.
- Remove the final gear cover and final gear, and inspect the coated teeth of the driven gear. The contact patch should be as shown below:
- If the tooth contact pattern is correct, as shown in (A), go to the Final Assembly section.
- If the tooth contact pattern is incorrect, as shown in (B), a thinner shim is needed between the final drive gear housing and final gear case.
- If the tooth contact pattern is incorrect, as shown in (C), a thicker shim is needed between the final drive gear housing and final gear case.
- If the tooth contact pattern is incorrect for either reason, the appropriate shim must be installed, and the tooth contact pattern re-checked by repeating the tooth coating procedure above.

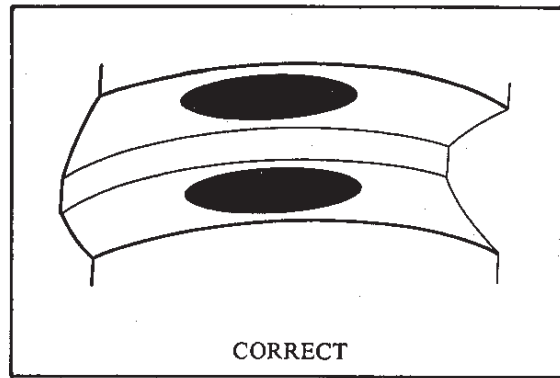

(A)

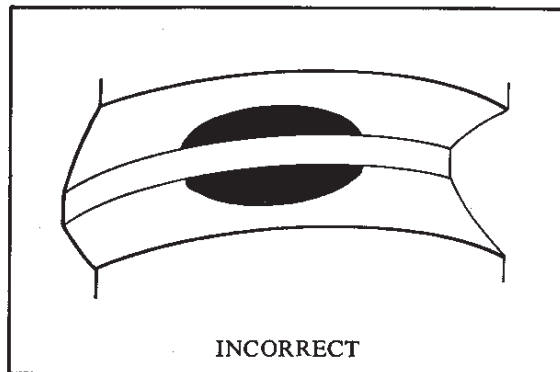

(B)

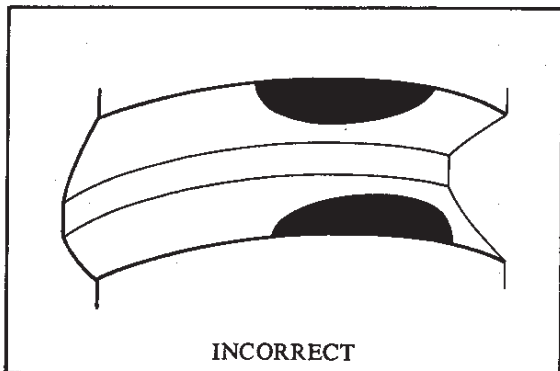

(C)

NOTE:

If it is necessary to adjust the shim thickness between final drive gear housing and final gear case, the final gear backlash may change, and should be re-checked according to the procedure outlined under the Backlash Measurement sub-section. Both adjustments may need to be changed until both backlash and tooth contact are correct.

List of Shims - final Drive Gear Housing to Final Gear Case

Part No.	Shim thickness
27445-45100	0.15 mm
27445-45101	0.30 mm
27445-45102	0.35 mm
27445-45103	0.40 mm

FINAL ASSEMBLY

- After adjusting the backlash tooth contact and clearance between the bearing cover and the bearing, remove the final gear cover, clean the mating surfaces thoroughly, and apply SUZUKI BOND No. 1201 to the final gear case should be limited to the surface shown below.

CAUTION:

- Thoroughly clean mating surfaces of final gear case and bearing case.
- Take care not to apply SUZUKI BOND No. 1201 to ribs (A) or not allow it to flow on to ribs.

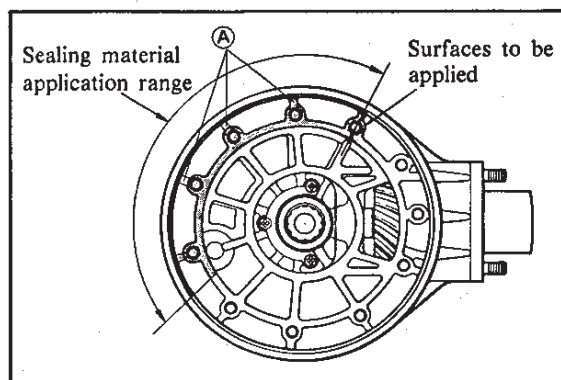

- Use special tools ① and ② to install a new oil seal into the final gear bearing cover.

NOTE:

Lip of seal with spring goes toward final driven gear.

①	Bearing and Oil Seal Installer Handle	09924-74510
②	Oil Seal Installer and remover	09924-74520

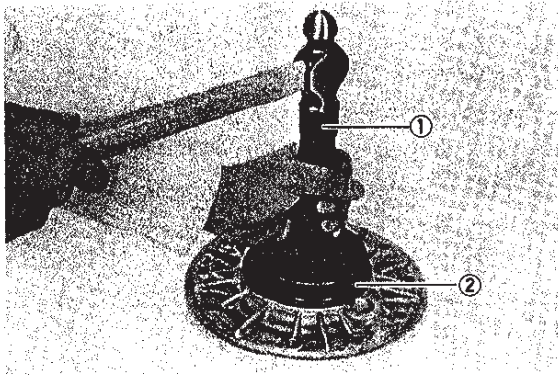

- Install the final gear bearing cover and tighten the 10 bolts to specification. Take care not to damage the seal lip.

Tightening Torque	20 – 26 kg·m
	2.0 – 2.6 kg·m
	14.5 – 19.0 lb·ft

- Remove the final drive gear housing from the final gear case.
- Liberally coat the final drive gear coupling splines with Lithium Base Molybdenum Grease (NLGI #2), and install the propeller shaft coupling spring and propeller shaft coupling.
- Push the coupling in against the spring and install the circlip.

Snap Ring Pliers	09900-06108
------------------	-------------

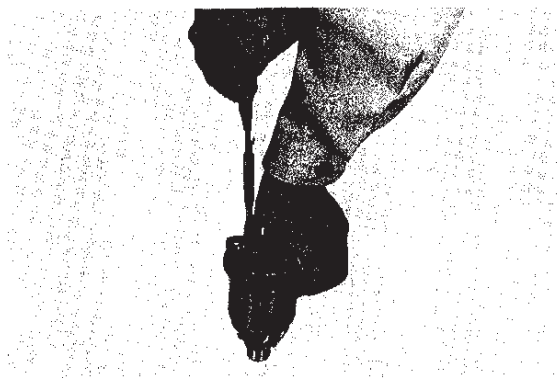

- Using special tool (3), install a new oil seal into the propeller shaft coupling.

Bearing Installer	09913-84510
-------------------	-------------

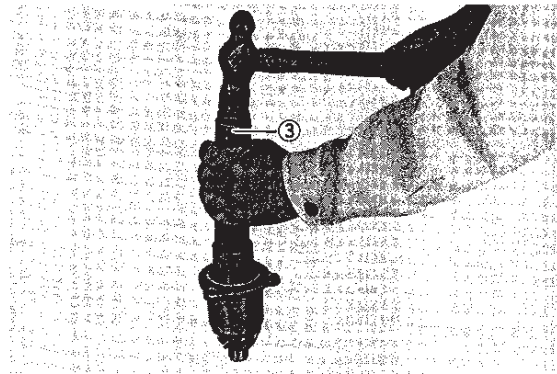

- Install a new o-ring on final drive gear housing, lubricate it lightly with Hypoid gear oil, and install the housing into the final gear case.

INSTALLATION OF PROPELLER SHAFT AND FINAL DRIVE GEAR ASSEMBLY

- For installation, reverse the procedure for removal.
- Apply SUZUKI BOND No. 1201 (99104-31100) to the end of the swing arm.
- Coat propeller shaft splines with Lithium Base Molybdenum Grease (NLGI #2).
- Install the final driven gear assembly, making sure the propeller shaft splines are aligned into the coupling.
- Torque the attachment nuts to specifications.

Tightening torque	35 – 45 N·m
	3.5 – 4.5 kg·m
	25.5 – 32.5 lb·ft

- Tighten the final gear case drain plug.

Tightening torque	20 – 30 N·m
	2.0 – 3.0 kg·m
	14.5 – 21.5 lb·ft

- Add Hypoid gear oil through filler hole until level is equal to filler hole opening level.

FULL-TRANSISTORIZED IGNITION SYSTEM

A fully transistorized ignition system is now employed on the GS1000GT. Its primary advantages are:

- * Trouble free operation due to elimination of contact breaker points which can become contaminated.
- * Ignition timing is maintained properly at all times and require no maintenance.
- * Free from arcing and provides the ignition coil with stable secondary voltage.
- * Excellent vibration and moisture resistance.

Transistor functions can be divided into four main functions:

1. Amplification
2. Switching
3. Oscillation
4. Modulation

These functions are utilized in the ignition system employed on the GS1000GT.

Transistors are divided into two groups, those being of the NPN and PNP types, and the transistors used in the GS1000GT model is of the NPN type only, works an amplifier and switching device.

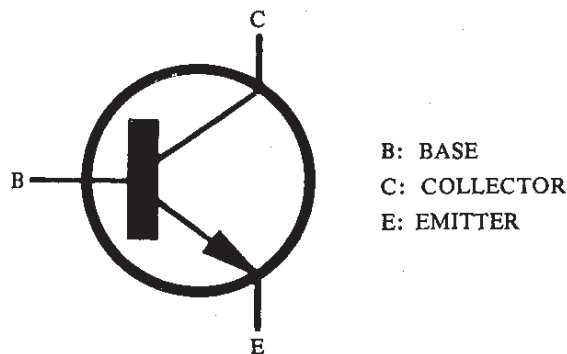

Each transistor has three terminals identified as the Base (B), Collector (C), and Emitter (E), and operation is as follows:

On a NPN type the base is the controlling terminal of the transistor operation. On this type, the base utilizes only a positive or incoming signal to do the "ON", or "OFF" switching. The collector is the terminal where voltage is supplied to the transistor and the emitter is the terminal for passing this current for useage when the base has the proper "signal". Usually the voltage applied across the collector to the emitter is much larger than that needed at the base. This allows a relatively low voltage at the base to control large working voltages across the collector to the emitter.

The transistor ignition system used on the GS1000GT is the Nippon Denso brand and consists of a signal generator, which employs a rotor and tow pick-up coils, the transistor unit, ignition coils, and spark plugs.

SIGNAL GENERATOR:

The signal generator is mounted on the right hand side of the engine in the area commonly used for the contact breaker points. It is comprised of an iron rotor attached to a mechanical advance mechanism and two pick-up coils, with magnets at their bases, affixed to a plate. Each pick-up coil consists of a coil or wire and a yoke or coil and is mounted 180° apart on the plate.

As the rotor tip is turned past the coils, AC current is produced and used for switching within the transistor unit.

The transistor unit controls power to the ignition coils and causes the spark plugs to fire at the proper time.

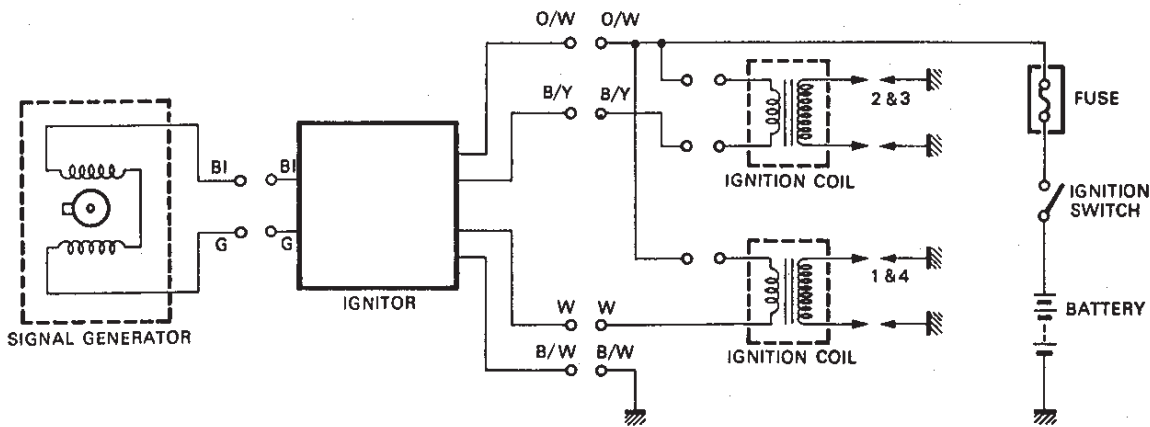

REMOVAL

- Remove signal generator cover.

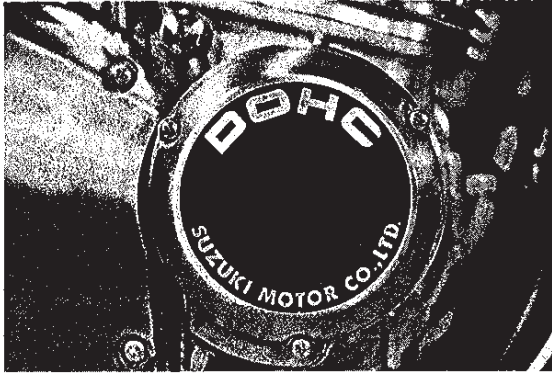

- Remove three screws and then remove the signal generator assembly and timing plate.

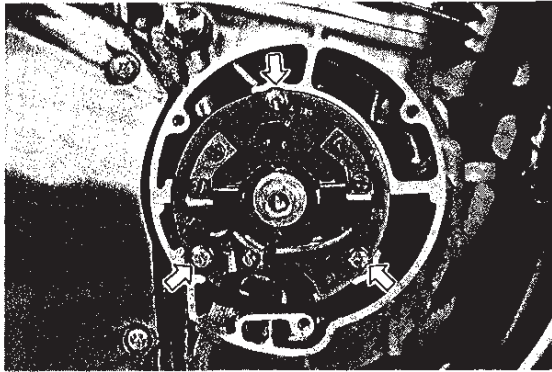

- Apply wrench to crank turning nut to remove automatic advance governor mounting bolts and the crank turning nut. Remove signal generator rotor and advance governor.

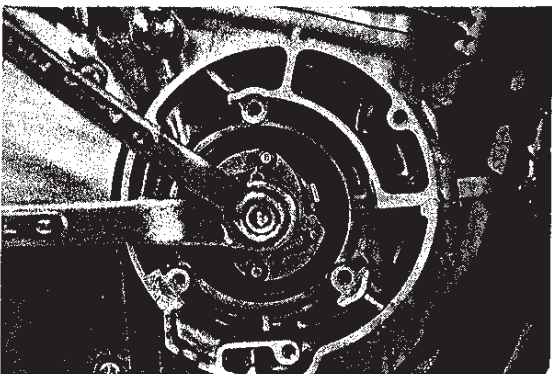

REASSEMBLY

- Make sure to fit the slot ① on the back surface of the automatic advance governor over the locating pin ② at the end of crankshaft.

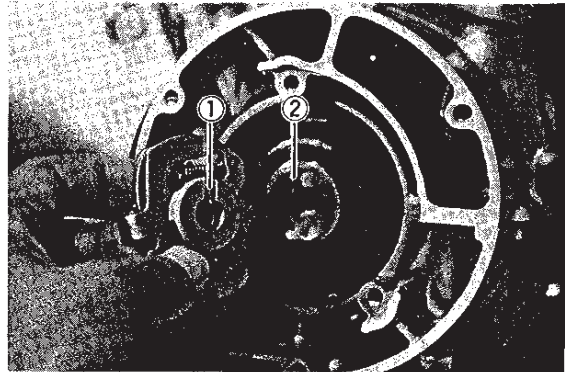

- Fit the groove ③ of the crankshaft turning nut on protrusion ④ of the advance governor body.

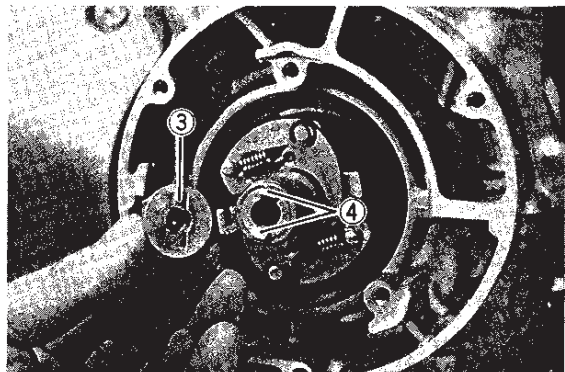

- Hold the crankshaft turning nut and tighten the governor center bolt with specified torque.

Tightening torque	13 - 23 N·m
	1.3 - 2.3 kg·m
	9.5 - 16.5 lb·ft

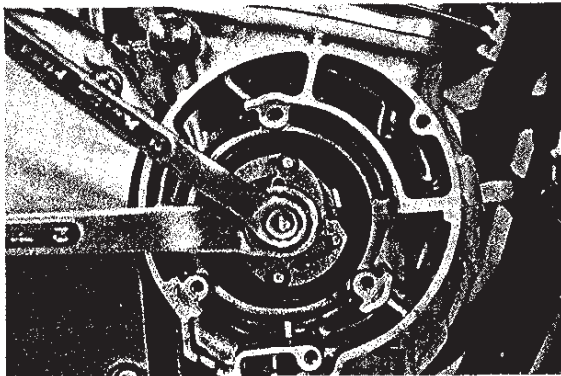

- Install the timing plate and signal generator so that the index line ① aligns with the index mark ②.

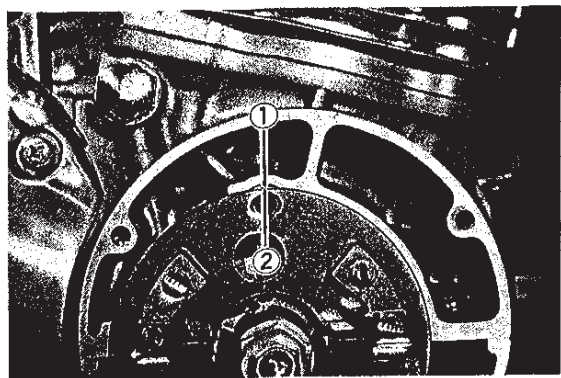

INSPECTION

IGNITION TIMING

Check the performance of the timing mechanism using the timing light. Illuminate the advance governor with the timing light and vary the engine speed to see if the ignition timing advances properly.

Ignition timing specifications

Ignition timing	17° B.T.D.C. below 1500 r/min and 37 — B.T.D.C. above 2350 r/min
-----------------	---

The procedure is as follows:

- Clip the timing light on the high tension cord of the No. 1 or No.4 cylinder.
- Run the engine at a speed not exceeding 1500 r/min. Under this condition, "F" mark on No. 1 and No. 4 cylinder side and timing mark should be in perfect alignment.
- Run the engine in the speed range above 2350 r/min, and similarly observe the position of mark ① relative to mark ②. If the two marks are in register, it means that the ignition is properly advanced.

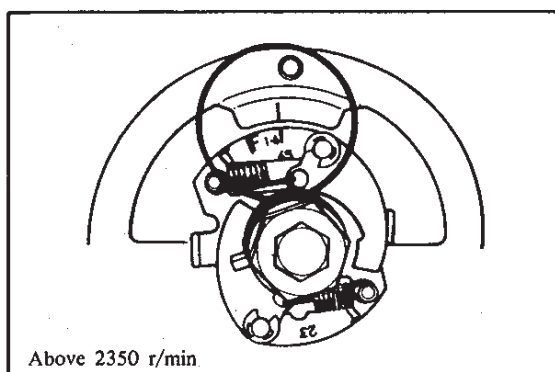
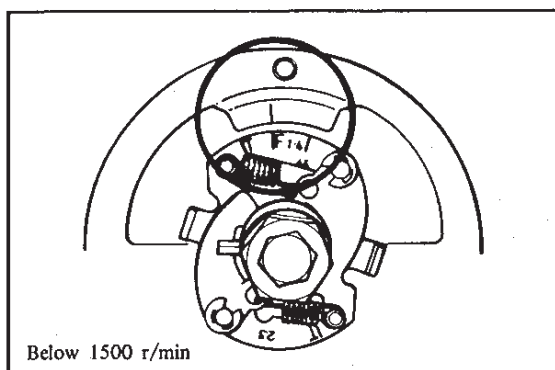

SIGNAL GENERATOR RESISTANCE

Measure the resistance between lead wires.
If the resistance noted to show infinity or too low a resistance value must be replaced.

09900-25002	Pocket tester
-------------	---------------

STD resistance	
BI - G	290 - 360 Ω

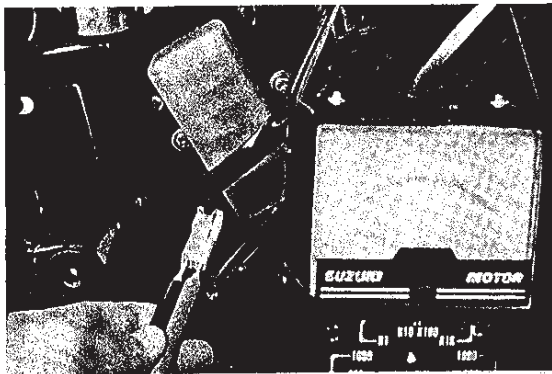

IGNITER

Remove each spark plug of Nos. 1 and 2 cylinders, fit it to respective plug cap and place it on the cylinder head.

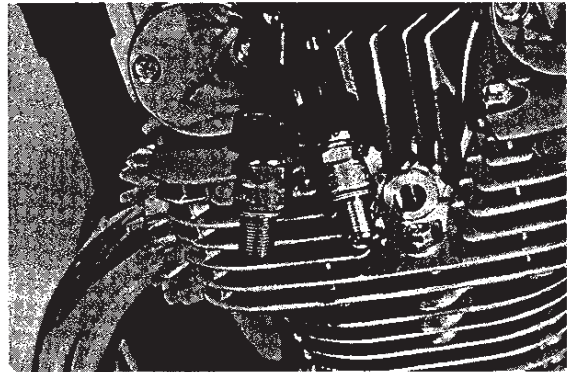

Remove the frame cover on the left side and disconnect the lead wire from the signal generator.

Now connect \oplus pin of SUZUKI Pocket Tester (X1 Ω range) with Blue lead wire on the igniter side and \ominus pin with Green lead wire. The igniter is in good condition if the following is observed: The moment the test pins are connected the spark plug of No. 2 cylinder sparks and the moment the tester pins are disconnected the spark plug of No. 1 cylinder sparks.

NOTE:

This checking presupposes that the ignition coil used for checking is a good one.

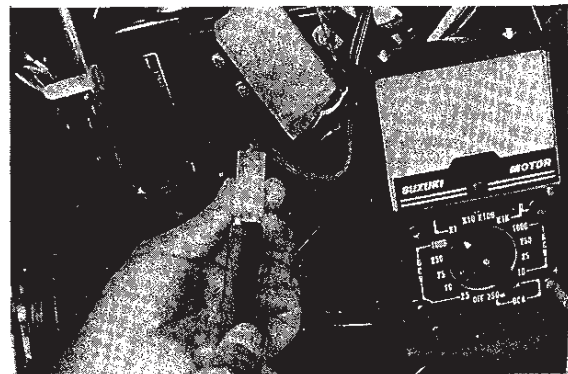

CHARGING SYSTEM

DESCRIPTION

The circuit of the charging system is shown in the figure, is composed of an AC generator, regulator/rectifier unit and battery.

The AC current generated from AC generator is rectified by rectifier and is turned into DC current, then it charges the battery.

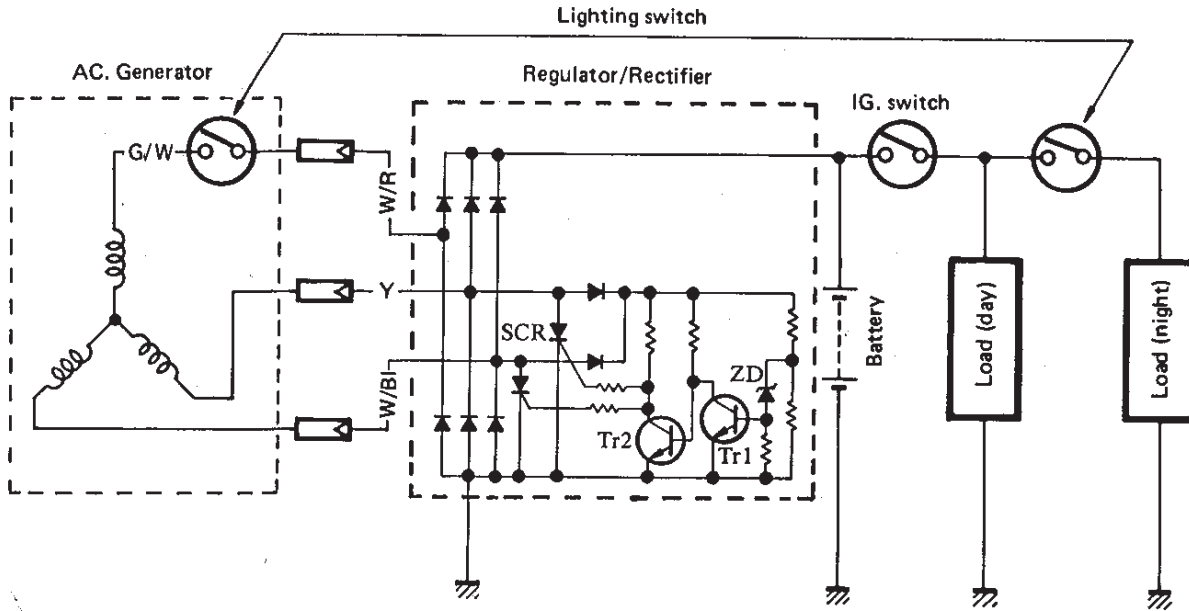

Function of Regulator

While the engine r/min is low and the generated voltage of AC generator is lower than the maximum allowable voltage, the regulator does not function.

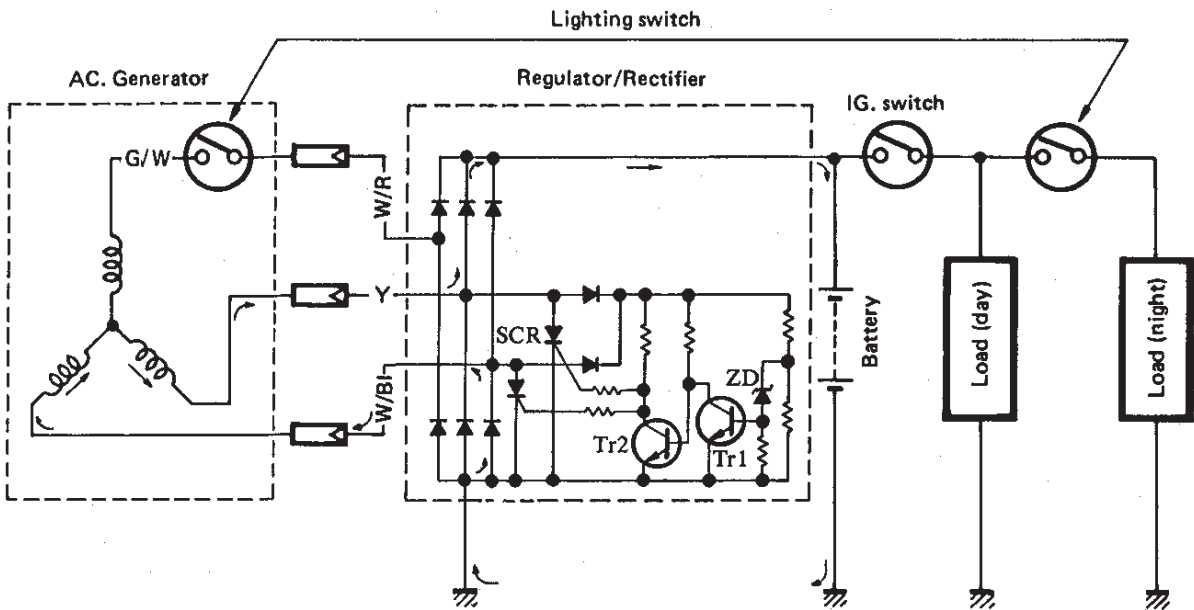

When the engine r/min becomes higher, the generated voltage of AC generator also becomes higher and the voltage between points **A** and **B** of regulator become high accordingly, and when it reaches the adjusted voltage of regulator, ZD (Zener diode) becomes "ON" condition and Tr1 becomes "ON" condition because the base current flows to Tr1 and also Tr2 becomes "ON" condition consequently because the base current flows to Tr2. When Tr2 becomes "ON", signal will be sent to the SCR (Thyristor) gate probe and SCR will become "ON" condition.

Then the SCR becomes conductive to the direction from point **C** to point **D**. Namely at the state of this, the current generated from the AC generator gets through SCR without charging the battery and returns to AC generator again. At the end of this state, since the AC current generated from AC generator flows into the point **D**, reverse current tends to flow to SCR, then the circuit of SCR turns to OFF mode and begins to charge the battery again. Thus these repetitions maintain charging voltage to the battery constant and protect it from overcharging.

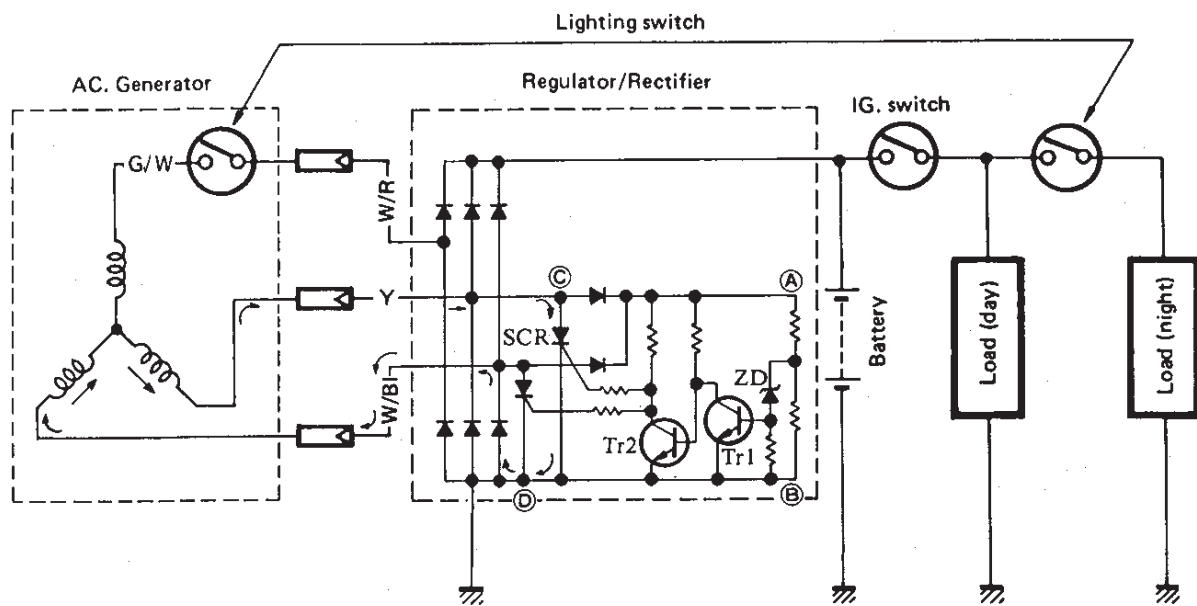

INSPECTION

Charging Output Check

- Start the engine and keep it running at 5 000 r/min.
- Using pocket tester, measure the DC voltage between the Battery ⊕ and ⊖ terminal.
- If the tester reads under 14V or over 15.5V, the regulator/rectifier may be faulty.

NOTE:
When making this test, be sure that the battery is in a fully-charged condition.

STD charging output
14 – 15.5V (DC) at 5 000 r/min

09900-25002	Pocket tester
-------------	---------------

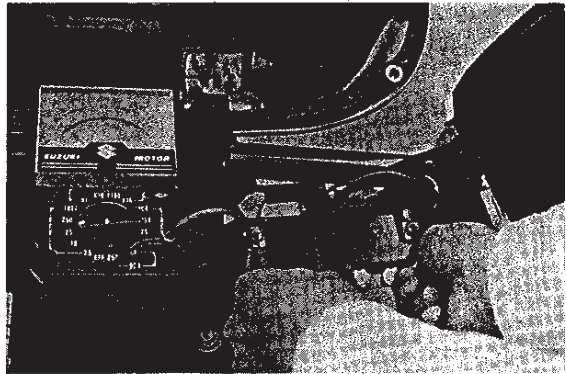

AC GENERATOR NO-LOAD PERFORMANCE

- Disconnect the three lead wires from the AC generator terminal.
- Start the engine and keep it running at 5 000 r/min.
- Using the pocket tester, measure the AC voltage between the three lead wires.
- If the tester reads under 80V, the AC generator is faulty.

STD No-load performance
80V (AC) or over at 5 000 r/min

09900-25002	Pocket tester
-------------	---------------

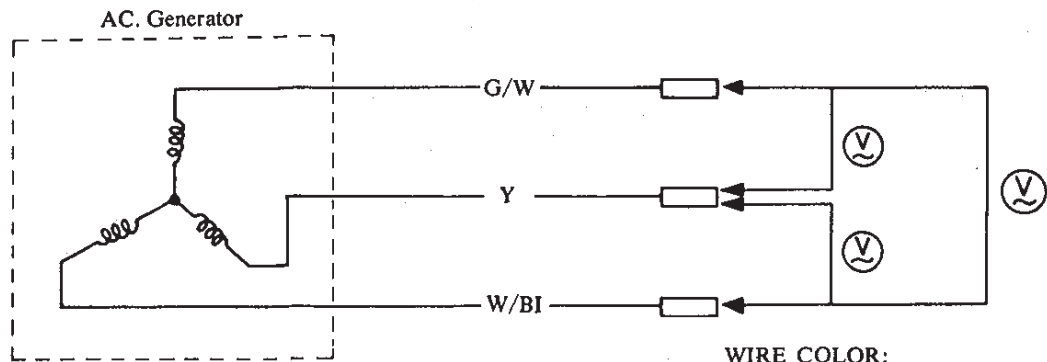
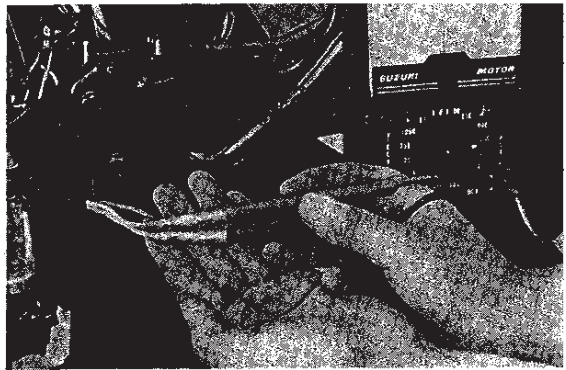

WIRE COLOR:
 Y Yellow
 W/BI..... White with Blue tracer
 G/W Green with White tracer

Using pocket tester, check the continuity between the lead wires of the stator.
Also check that the stator core is insulated.

09900-25002	Pocket tester
-------------	---------------

Specification	Approx. 1Ω
---------------	------------

NOTE:
When making this test, it is not necessary to remove the AC generator.

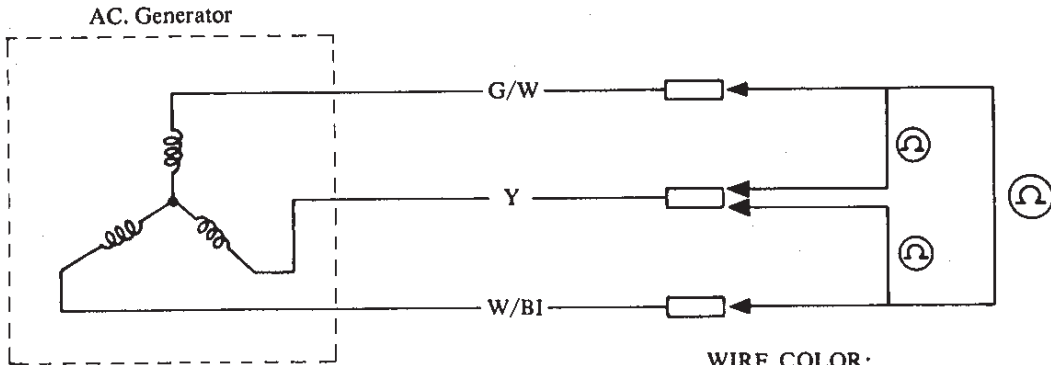

WIRE COLOR:
Y Yellow
W/BI..... White with Blue tracer
G/W Green with White tracer

REGULATOR/RECTIFIER

Using pocket tester (X1Ω range), measure the resistance between the lead wires in the following table.
If the resistance reading is incorrect, replace the regulator/rectifier.

09900-25002	Pocket tester
-------------	---------------

Unit: Ω

		⊕ Probe of tester				
		R	W/BI	W/R	Y	B/W
⊖ Probe of tester	R	∞	∞	∞	∞	∞
	W/BI	5-7	∞	∞	∞	Approx. 200
	W/R	5-7	∞	∞	∞	∞
	Y	5-7	∞	∞	∞	Approx. 200
	B/W	35-45	5-7	5-7	5-7	∞

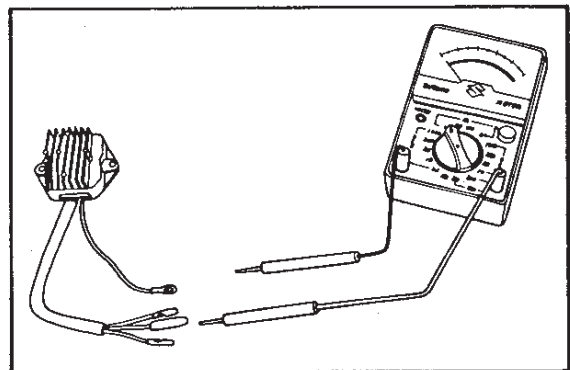

FRONT FORK

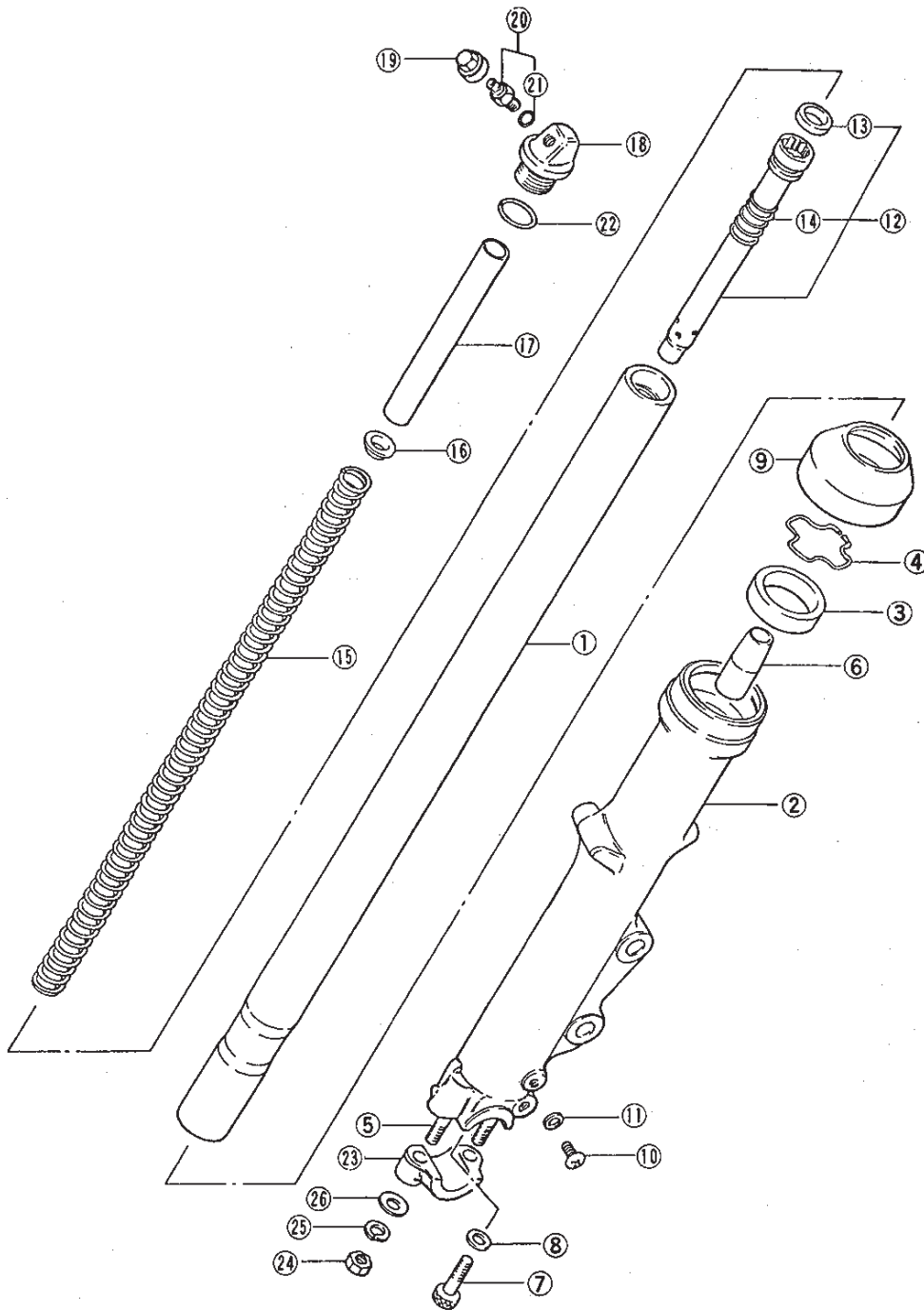

- 1. Inner tube
- 2. Outer tube
- 3. Oil seal
- 4. Oil seal stopper ring
- 5. Stud bolt
- 6. Oil lock piece
- 7. Bolt
- 8. Gasket
- 9. Dust seal
- 10. Screw
- 11. Gasket
- 12. Cylinder
- 13. Piston ring
- 14. Spring
- 15. Spring
- 16. Spring guide
- 17. Spacer
- 18. Upper cap
- 19. Valve cap
- 20. Valve
- 21. O ring
- 22. O ring
- 23. Axle holder
- 24. Nut
- 25. Lock washer
- 26. Washer

Tightening torque			
	N·m	kg·m	lb·ft
⑦	20 - 26	2.0 - 2.6	14.5 - 19.0
⑱	15 - 30	1.5 - 3.0	11.0 - 25.5
⑳	10 - 13	1.0 - 1.3	7.0 - 9.5
㉔	15 - 25	1.5 - 2.5	11.0 - 18.0

INSPECTION

- Inspect front fork spring.
Measure the free length of the fork spring.
Replace it with a new one when it is less than the service limit.

Limit	416 mm (16.4 in)
-------	------------------

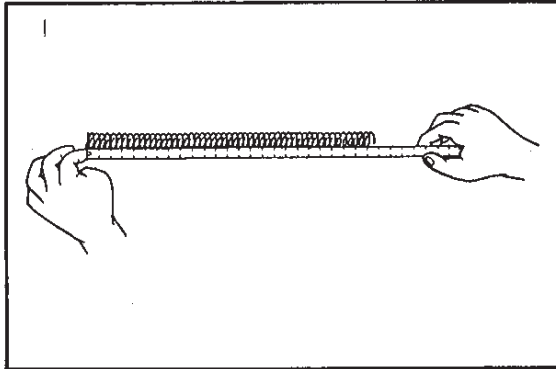

- Inspect the inner tube.
Visually inspect the sliding surface of the inner tube. Replace the inner tube with a new one if any flaws are found.
- Inspect the outer tube.
Visually inspect the outer tube to see whether it is dented or damaged.
- Inspection for oil leakage.
Replace the oil seal with a new one if oil leakage is found. Leakage is caused by intrusion of dust or flaws on the inner tube.

CAUTION:

Install the front fork spring that the closed pitch end is in up side.

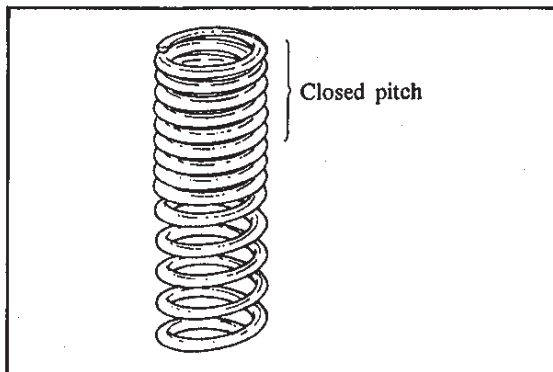

FRONT MASTER CYLINDER

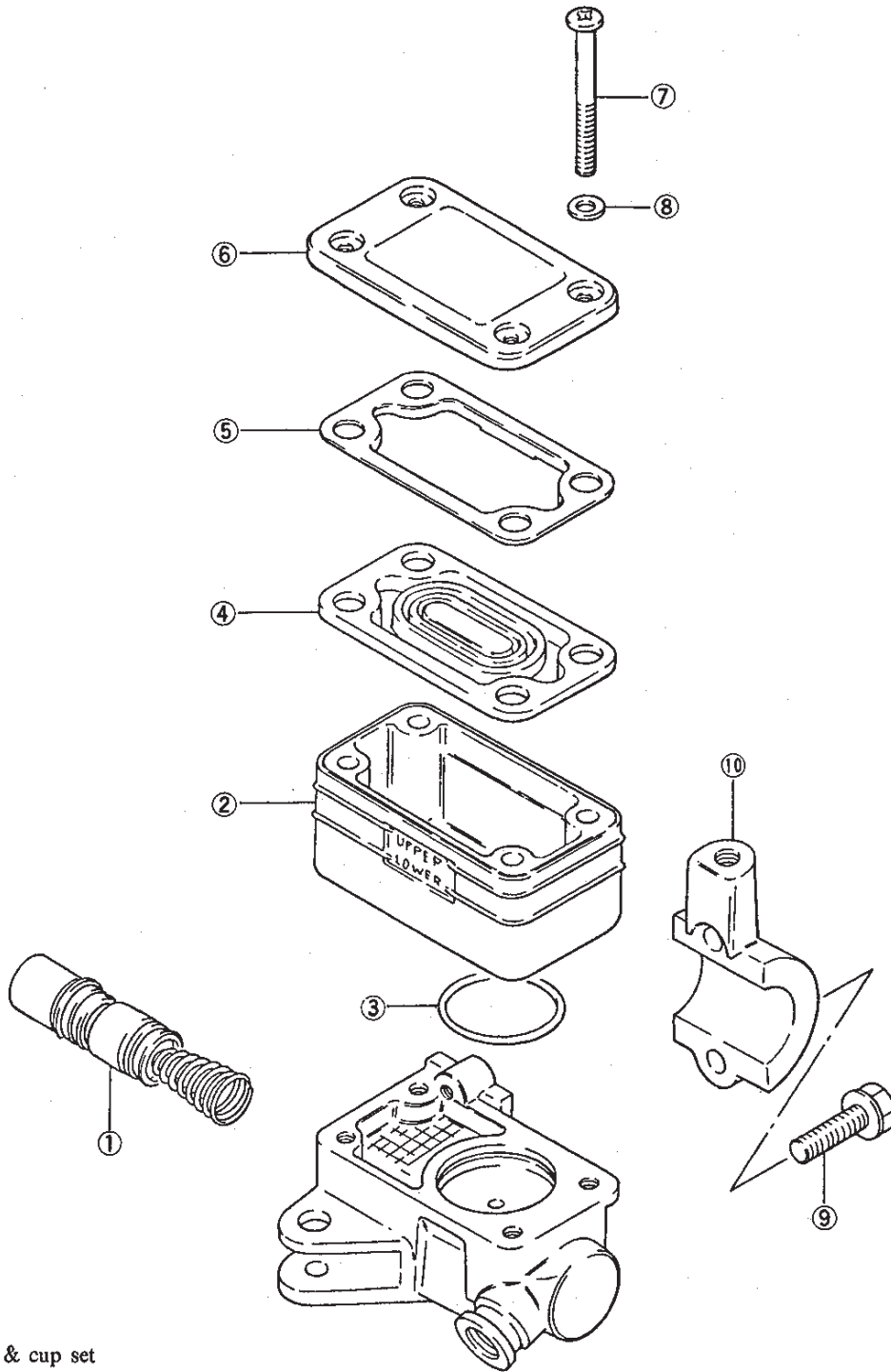

- 1. Piston & cup set
- 2. Reservoir
- 3. O ring
- 4. Diaphragm
- 5. Plate
- 6. Cap
- 7. Screw
- 8. Washer
- 9. Bolt
- 10. Holder

Tightening torque			
	N·m	kg·m	lb·ft
⑨	5 - 8	0.5 - 0.8	3.5 - 6.0

MASTER CYLINDER REMOVAL AND DISASSEMBLY

- Take off front brake light switch.

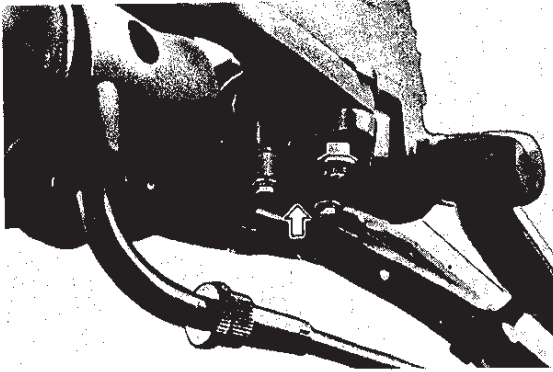

- Remove front brake lever.

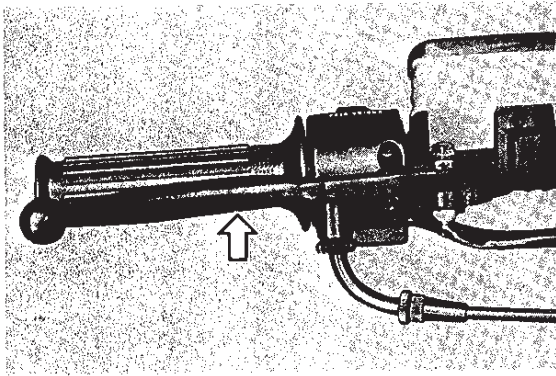

- Place a rag underneath the union bolt on the master cylinder to catch spilled drops of brake fluid. Unscrew the union bolt and disconnect the brake hose/master cylinder joint.

CAUTION:

Completely wipe off any brake fluid adhering to any part of motorcycle. The fluid reacts in chemically with paints, plastics, rubber materials, immediately.

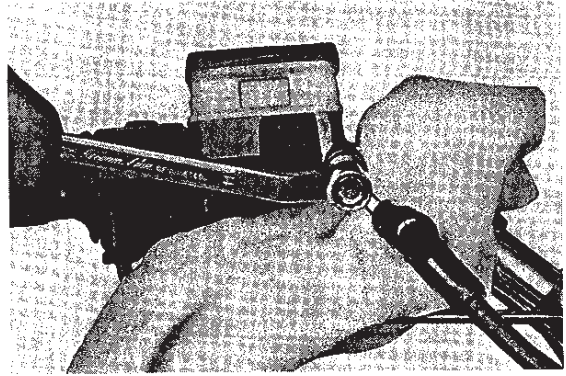

- Remove master cylinder ass'y after removing two fitting bolts.

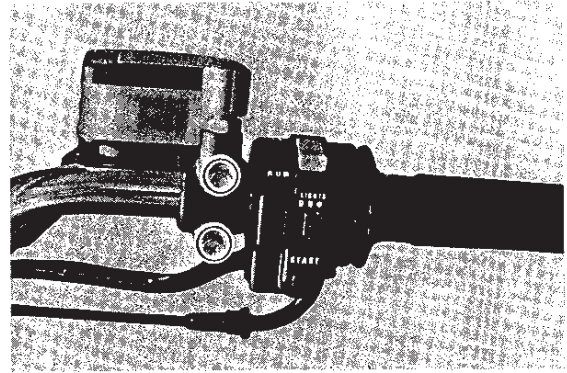

- Remove filler cap and drain brake fluid.

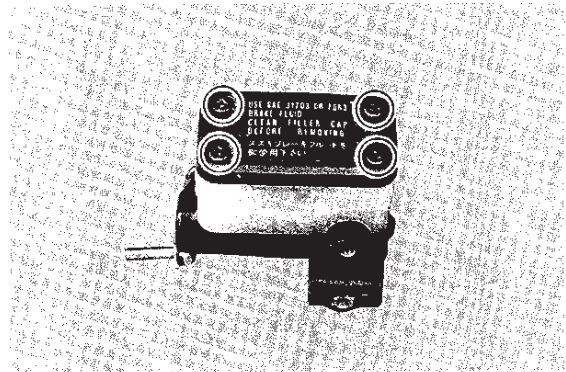

- Pull out the reservoir and O ring.

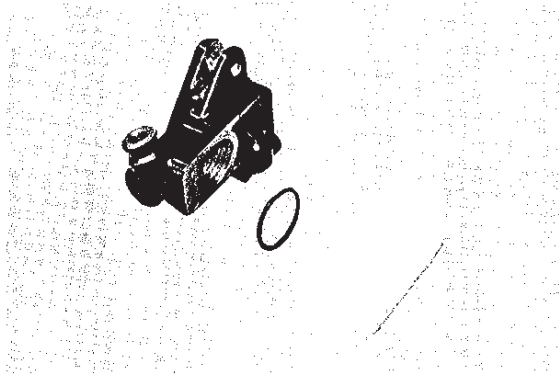

- Pull out piston, primary cup and spring.

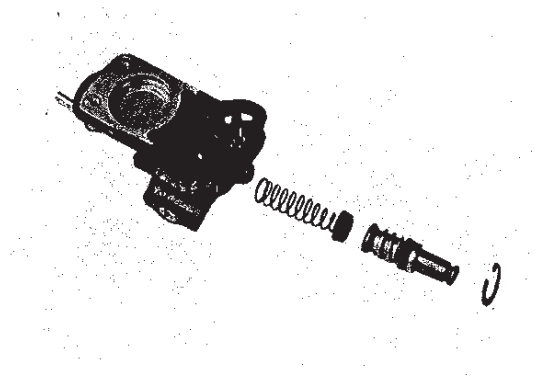

- Draw out dust seal boot.

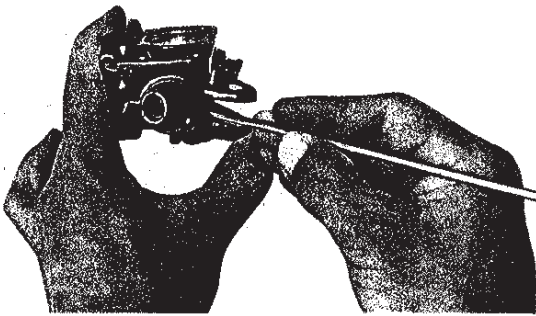

- Remove circlip by using special tool.

09900-06108	Snap ring pliers
-------------	------------------

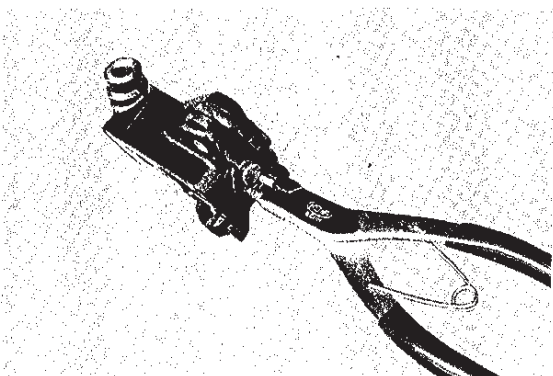

MASTER CYLINDER INSPECTION

- Inspect the cylinder bore wall for any scratch or other damage.

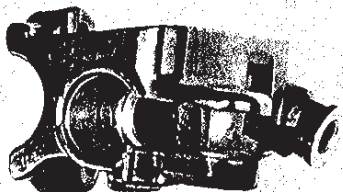

- Inspect the piston surface for scratch or other damage.



- Inspect the primary cup, secondary cup and dust seal boot for damage.



MASTER CYLINDER REASSEMBLY

- Reassemble the master cylinder in the reverse orders of disassembly and by taking the following steps:

CAUTION:

Wash the master cylinder components with fresh brake fluid before reassembly. Never use cleaning solvent or gasoline to wash them.

Apply brake fluid to the cylinder bore and all the internals to be inserted into the bore.

- When remounting the master cylinder to the handlebars, first tighten the clamp bolt for the upper portion as shown.

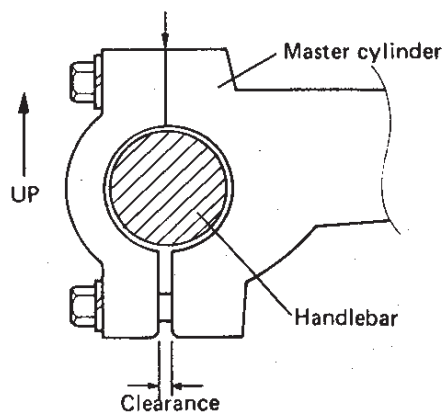

CAUTION:

Adjust the front brake light switch after installation.

Bleed the air after reassembling master cylinder.

FRONT CALIPER

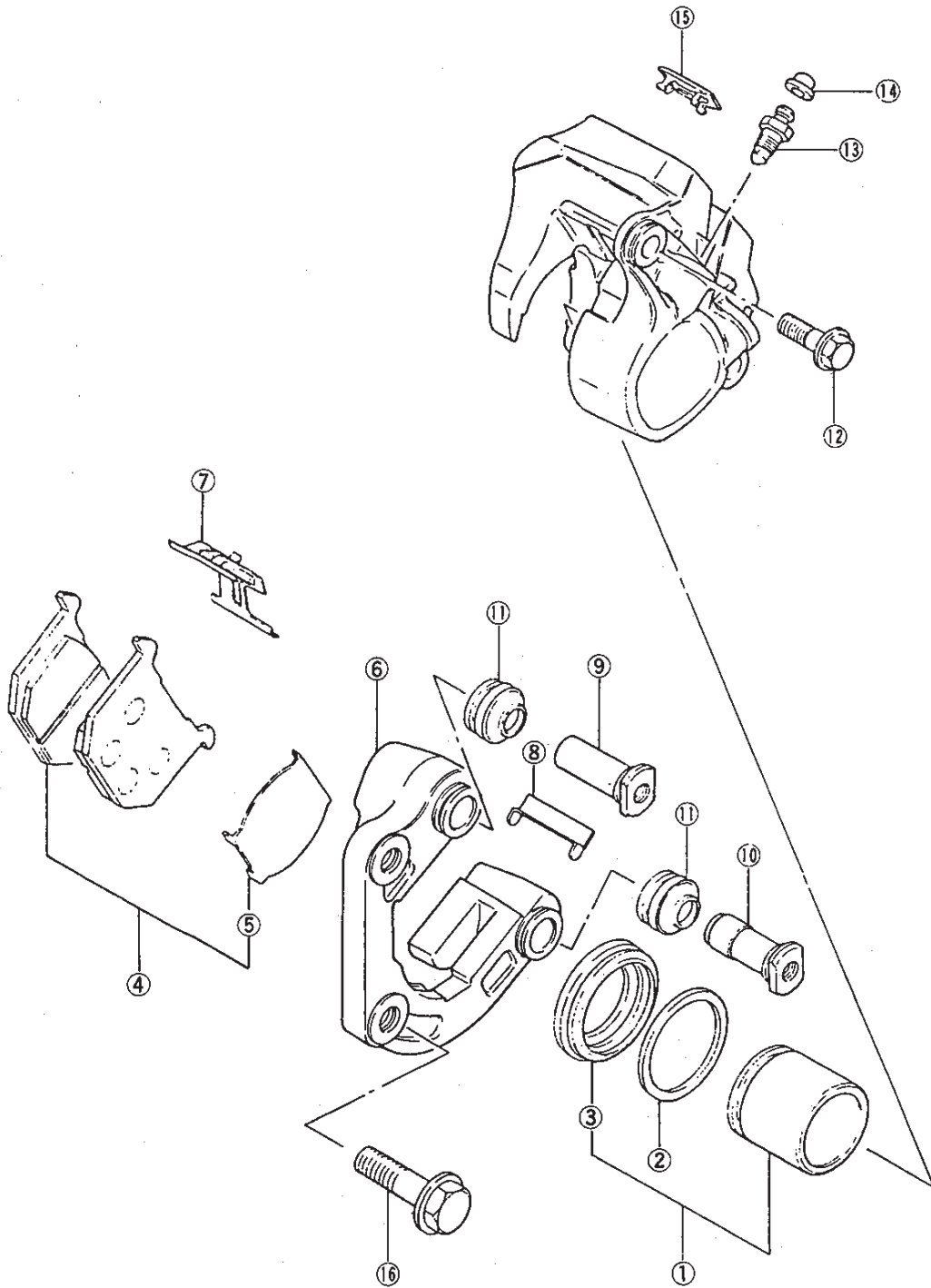

- 1. Piston set
- 2. Piston seal
- 3. Piston boot
- 4. Pad set
- 5. Pad shim
- 6. Caliper holder
- 7. Pad spring
- 8. Pad guide
- 9. Caliper axle No. 1
- 10. Caliper axle No. 2
- 11. Axle boot
- 12. Bolt
- 13. Bleeder
- 14. Cap
- 15. Cover
- 16. Bolt

Tightening torque			
	N·m	kg·m	lb·ft
⑫	15-20	1.5-2.0	11.0-14.5
⑯	25-40	2.5-4.0	18.0-29.0

BRAKE PAD REPLACEMENT

- Remove two bolts and take off caliper.

CAUTION:

Do not operate the brake lever when removing the caliper.

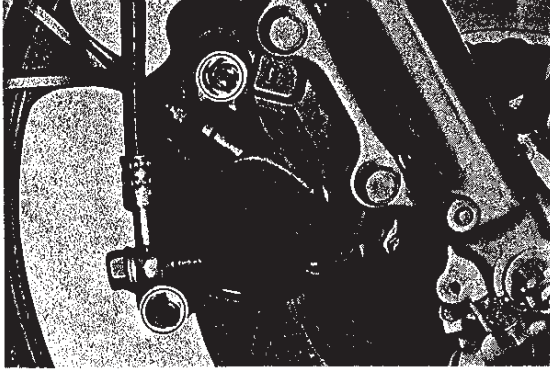

- Pull out brake pads with pad shim.

CAUTION:

Replace the brake pad with a set, otherwise braking performance will be adversely affected.

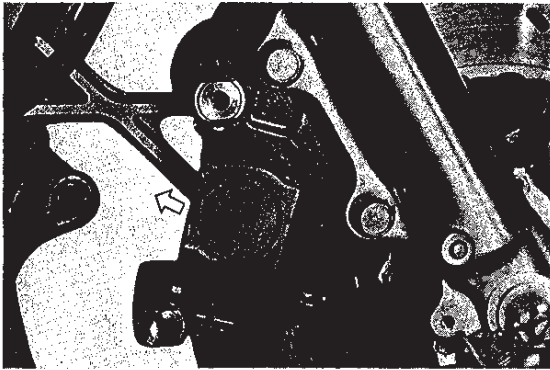

CAUTION:

Do not apply pad grease, when installing the brake pads.



NOTE:

Push in the piston all the way before remounting the caliper.

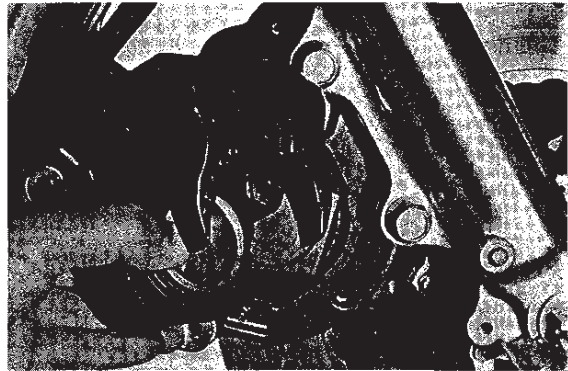

- Tighten the caliper axle bolts with specified torque.

Tightening torque	15 – 20 N·m
	1.5 – 2.0 kg·m
	11.0 – 14.5 lb·ft

CALIPER REMOVAL AND DISASSEMBLY

- Disconnect brake hose and catch the brake fluid in a suitable receptacle.



- Remove caliper axle bolts and take off caliper.

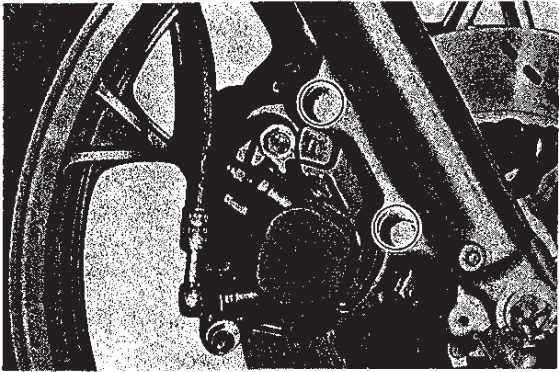

- Place a rag over the piston to prevent popping up. Draw out the piston by using air gun.

CAUTION:

Do not use high pressure air for preventing piston damage.



- Remove caliper bracket and draw out caliper axles.

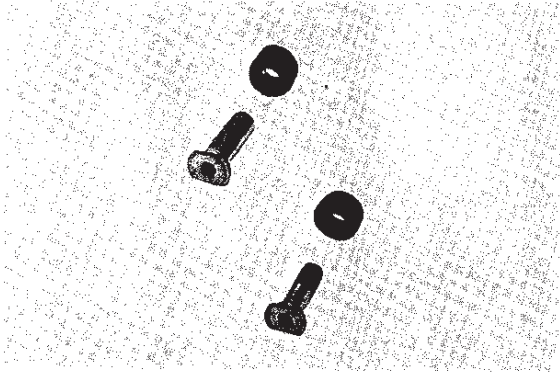

- Remove piston boot and piston seal.

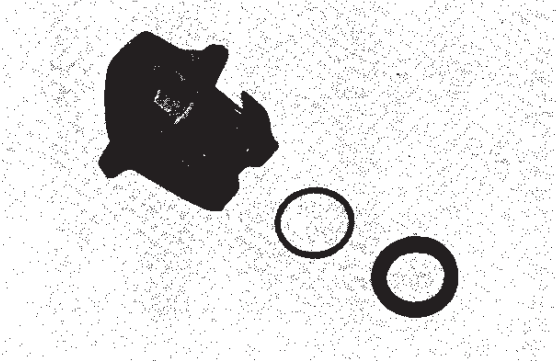

CALIPER AND DISC INSPECTION

- Inspect the cylinder bore wall for nick, scratch or other damage.

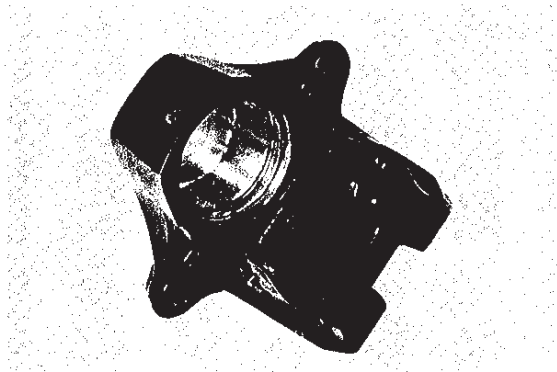

- Inspect the piston surface for any flow or other damage.

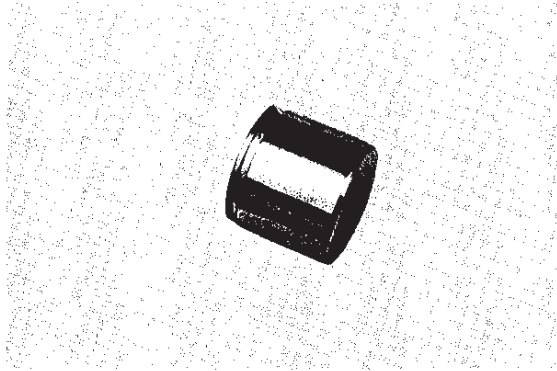

- Inspect each rubber part for damage and wear.

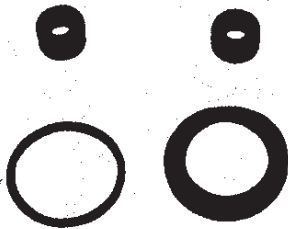

CALIPER REASSEMBLY

- Reassemble the caliper in the reverse orders of disassembly and by taking the following steps:

CAUTION:

Wash the caliper components with fresh brake fluid before reassembly.

Never use cleaning solvent or gasoline to wash them.

Apply brake fluid to the caliper bore and piston to be inserted into the bore.

- Apply grease to the caliper axles.

99000-25100	Suzuki silicone grease
-------------	------------------------

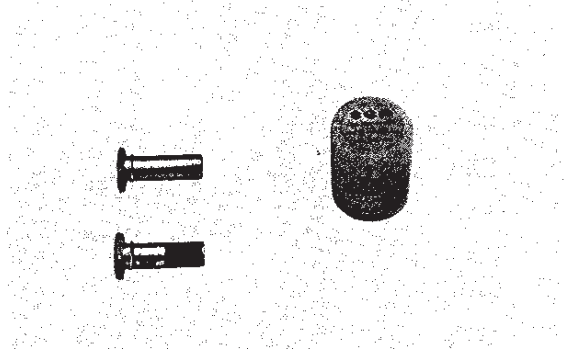

- Tighten the caliper axle nuts and caliper mounting bolts with specified torque.

	Tightening torque
Caliper axle bolt	15 — 20 N•m
	1.5 — 2.0 kg•m
	11.0 — 14.5 lb•ft
Caliper bolt	25 — 40 N•m
	2.5 — 4.0 kg•m
	18.0 — 29.0 lb•ft

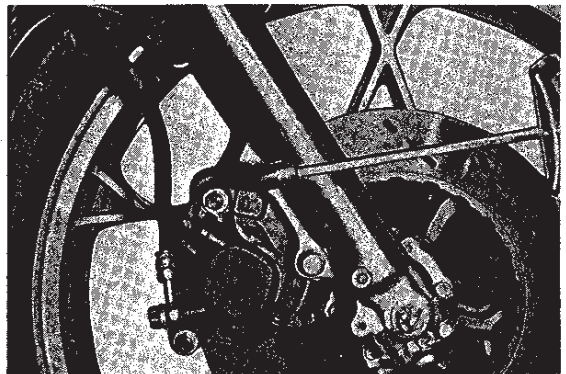

REAR WHEEL

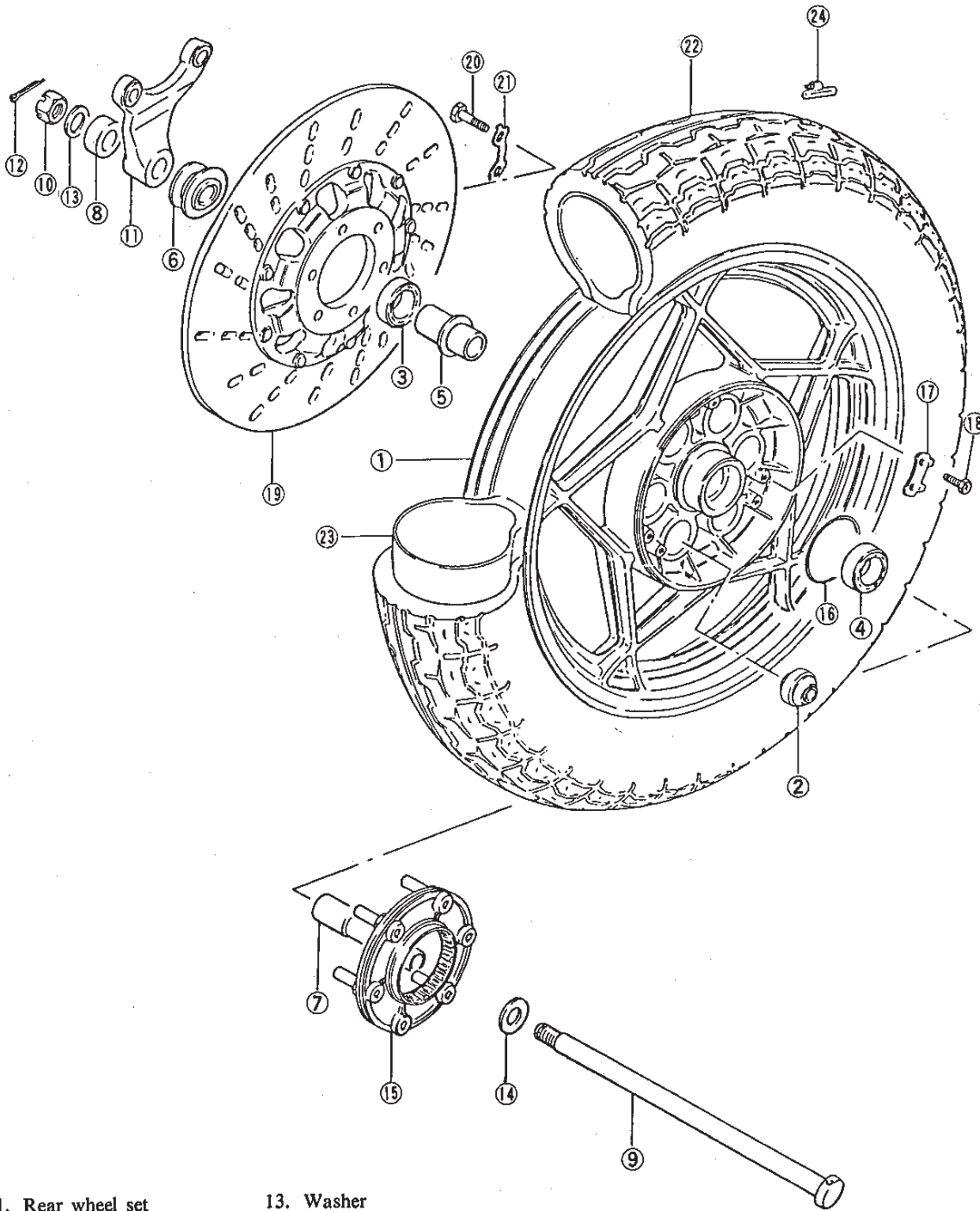

- | | |
|--------------------------|---------------------|
| 1. Rear wheel set | 13. Washer |
| 2. Cushion | 14. Washer, LH |
| 3. Bearing, RH | 15. Driven joint |
| 4. Bearing, LH | 16. O ring |
| 5. Bearing spacer | 17. Washer |
| 6. Spacer RH | 18. Bolt |
| 7. Spacer, LH | 19. Rear brake disc |
| 8. Spacer, RH | 20. Bolt |
| 9. Rear axle | 21. Washer |
| 10. Nut | 22. Rear tire |
| 11. Rear caliper bracket | 23. Inner tube |
| 12. Cotter pin | 24. Balancer |

Tightening torque			
	N•m	kg•m	lb•ft
⑩	50-80	5.0-8.0	36.0-58.0
⑳	15-25	1.5-2.5	11.0-18.0

REMOVAL AND DISASSEMBLY

- Locate the motorcycle on level ground and place the motorcycle on the centerstand.

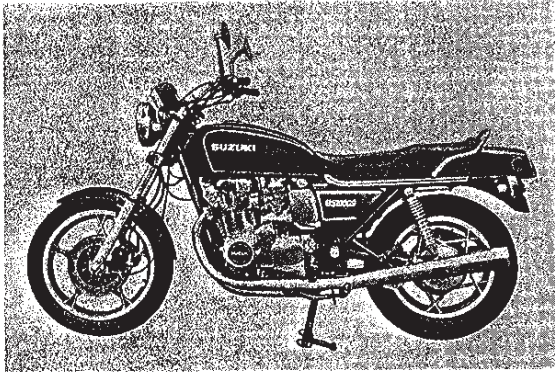

- Insert the crosshead screwdriver into the right side of the centerstand pivot to prevent the motorcycle from tipping off the centerstand.



- Remove the upper shock absorber nuts and loosen the lower shock absorbers free from the mounting lugs. This will allow the swinging arm/bevel gear assembly to be easily moved.

CAUTION:

Take care not to burn yourself if the mufflers are hot.

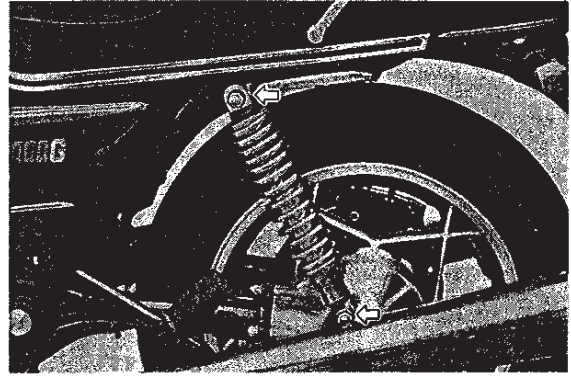

- Lift the swinging arm/bevel gear assembly by attaching a 14 mm wrench to one of the caliper bolts and use the wrench as a lift handle. While lifting the swinging arm/bevel gear assembly insert a socket wrench handle through the right muffler support and swinging arm hole. This will hold the swinging arm in the correct position for removing the rear wheel axle.

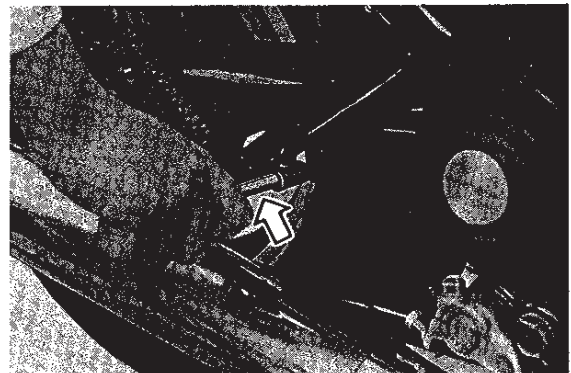
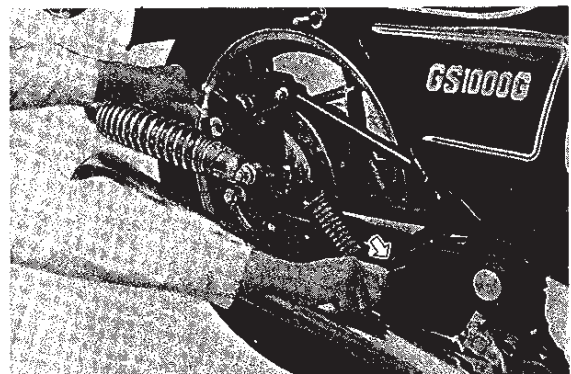

- Remove both right and left rear shock absorbers.

- Remove the rear torque link cotter pin ①, bolt, nut and support bolt ② for brake hose.
- Remove the axle cotter pin ③ and axle nut ④.

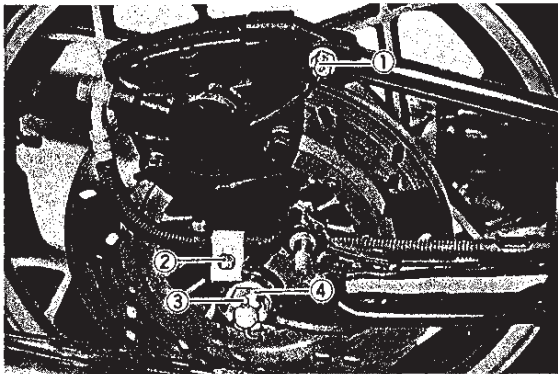

- Remove the axle, while at the same time supporting the caliper assembly. After the axle is clear off the caliper, hand the caliper on the upper shock absorber mount stud.

CAUTION:

Do not allow the brake hose to touch the hot muffler. Protect it by wrapping the hose with a rag.

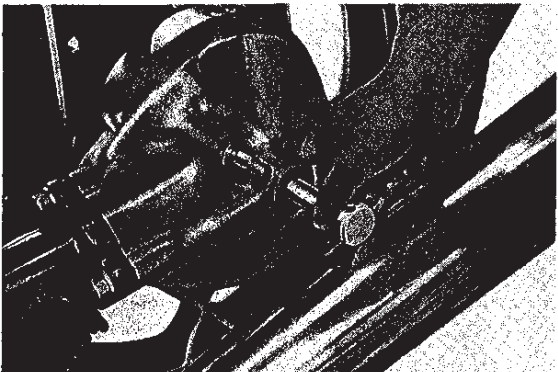

- Remove the axle from the differential housing. Remove the wheel from the splined drive and set the wheel assembly on the ground.

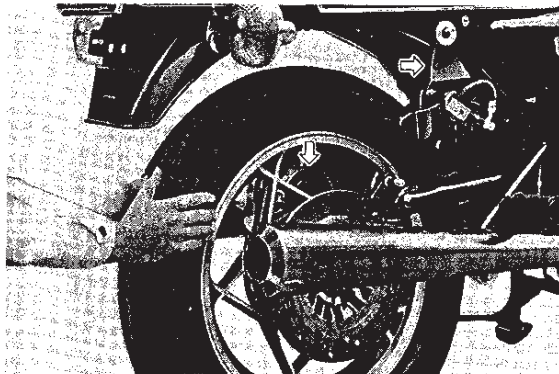

- The front forks must be compressed in order to tilt the back of the motorcycle upward so that the tire can be removed from the fenderwell area. To compress the forks turn the forks to the right fork stop. Hang the front fork compressing tool hook ⑤ on the left front fender boss. Hang the wire loop ⑥ on the left fork stop. Pivot the front fork compressing tool handle to compress the forks, then hang the hook ⑦ on the tool lever handle to hold the forks in the compressed position.

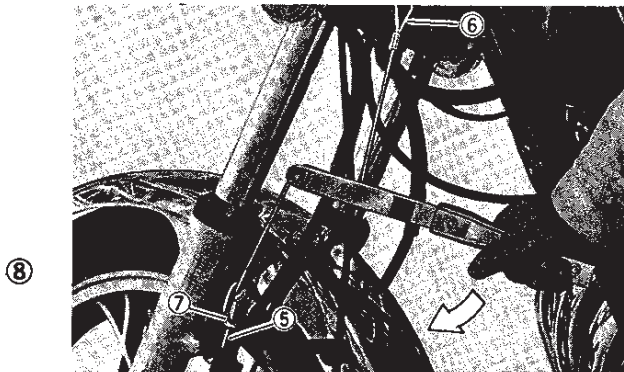

⑧

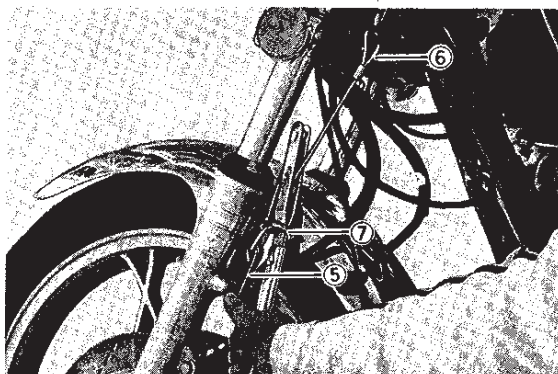

- Remove the rear wheel assembly.

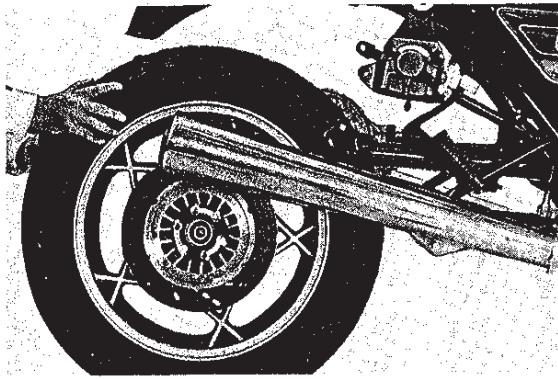

- Bend up the lock washer, remove the bolts and separate the disk from the wheel.
- Bend up the lock washer, remove the bolts and separate the driven joint from the wheel.

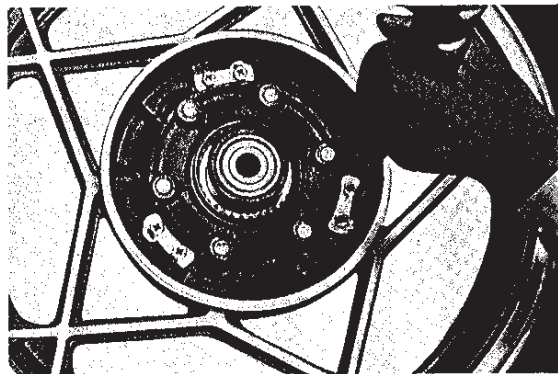

- Remove the bushings from the wheel.
- Remove the right and left bearings.

REASSEMBLY

- Drive bushings into the wheel.

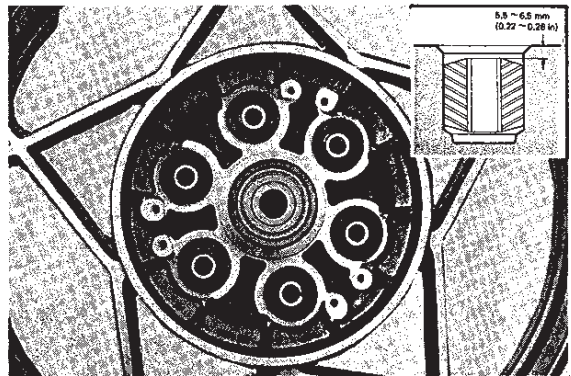

- Insert driven joint into wheel busing.

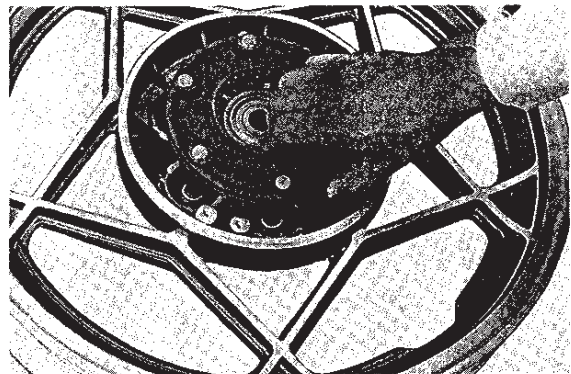

- Place three washers in the groove around the driven joint and tighten six bolts. Then bend washers to lock the bolts.

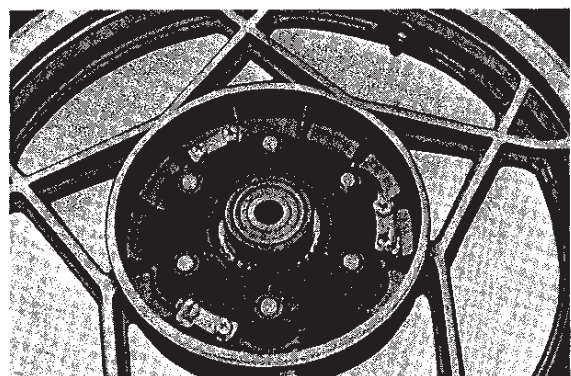

- Insert the rear wheel assembly under the rear fenderwell area.
- Remove the front fork compressing tool from the front fork.
- Fit the wheel assembly back onto the splined engagement shaft. Insert the axle through to the right side of the swinging arm. Install and tighten the axle nut securely. Fit the cotter pin in the axle nut.

CAUTION:

When reinstalling the rear caliper be careful not to twist the brake hose or route it improperly. Never depress the brake pedal with the rear wheel removed as it is very difficult to force the brake pads back into the caliper assembly.

- Install the rear torque link in the caliper assembly. Remember to reinstall the cotter pin after tightening the bolt and nut.
- Remove the socket wrench handle and replace the shock absorbers. Tighten their securing nuts to specification below.
- Remove the screwdriver from the center stand pivot.

Tightening torque

Rear axle shaft nut	85 — 115 N·m 8.5 — 11.5 kg·m 61.5 — 83.0 lb·ft
Torque link nut	20 — 30 N·m 2.0 — 3.0 kg·m 14.5 — 21.5 lb·ft
Rear shock absorber nut	20 — 30 N·m 2.0 — 3.0 kg·m 14.5 — 21.5 lb·ft

REAR SWINGING ARM

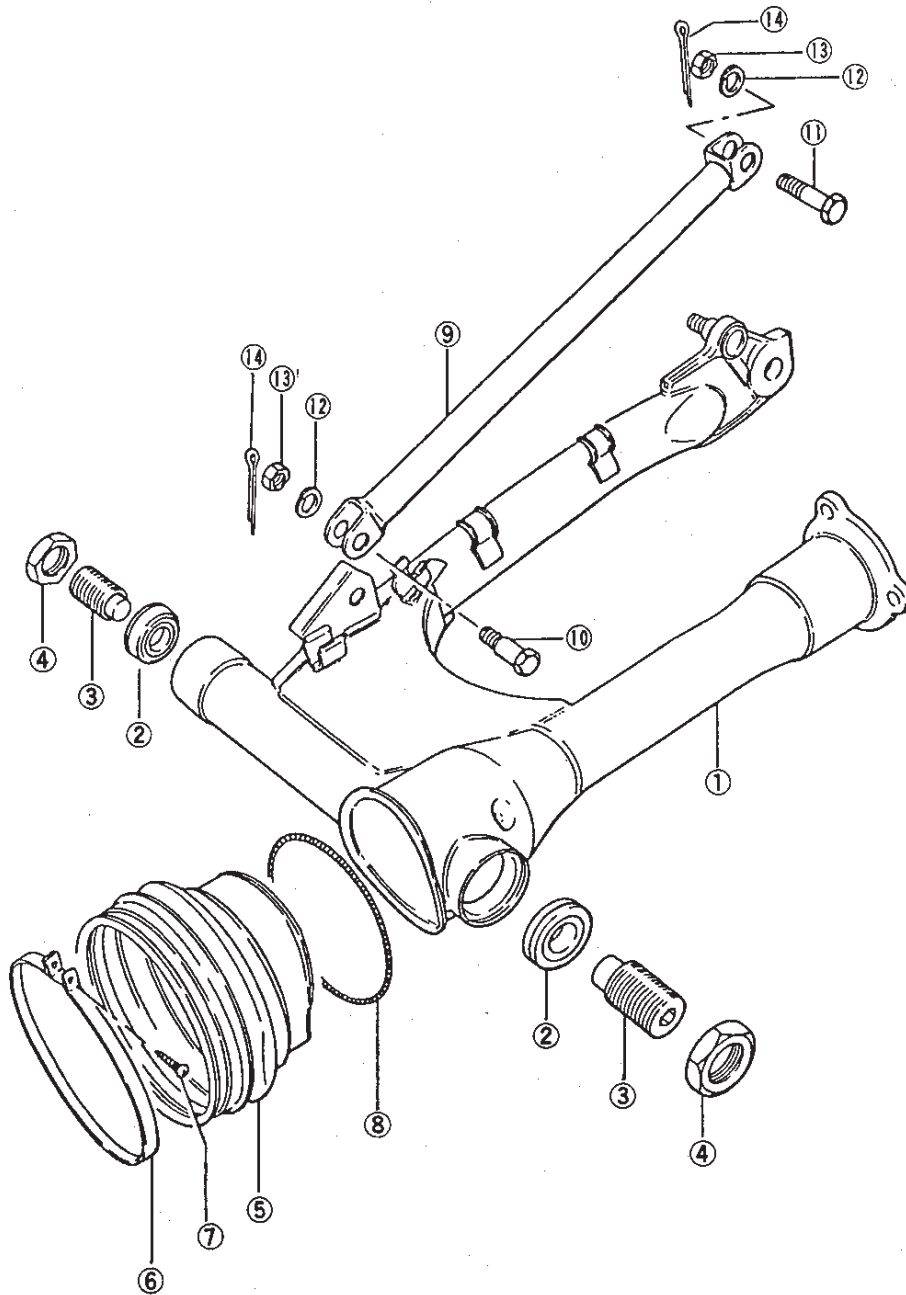

- | | |
|--------------------------|---------------------|
| 1. Rear swinging arm set | 8. Spring |
| 2. Bearing | 9. Rear torque link |
| 3. Pivot shaft | 10. Front bolt |
| 4. Nut | 11. Rear bolt |
| 5. Drive shaft boot | 12. Lock washer |
| 6. Clamp | 13. Nut |
| 7. Screw | 14. Cotter pin |

Tightening torque			
	N·m	kg·m	lb·ft
③	3.5—4.5	0.35—0.45	2.5—3.0
④	110—130	11.0—13.0	79.5—94.0
⑬	20—30	2.0—3.0	14.5—21.5

REMOVAL

- Remove the rear wheel (See page 95)
- Remove the brake hose from the clamp on the swinging arm, tie the rear brake caliper with a string and hook it on to the frame.

CAUTION:

Be careful not to bend or twist the brake hose.

- Remove the final drive gear assembly.
- Remove the ring holding the secondary boot and slide the boot to the other side.
- Remove the rear stop light switch.
- Remove the cotter pin from the master cylinder pushrod.
- Remove the rear swinging arm nuts ① and loosen the pivot shafts ②.

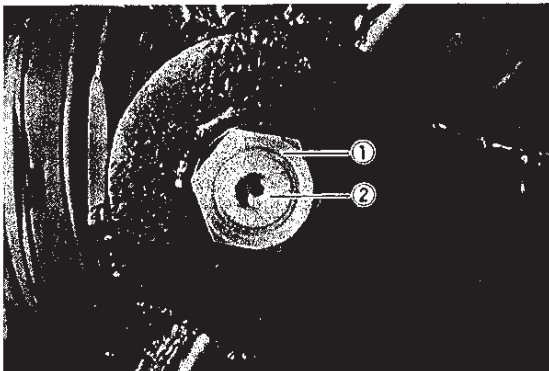

- Pull the rear swinging arm rearward and remove it from the frame.

CAUTION:

When removing the rear swinging arm, the inner roller bearing on both right and left sides could easily fall off the bearing. Exercise care to prevent this happening.

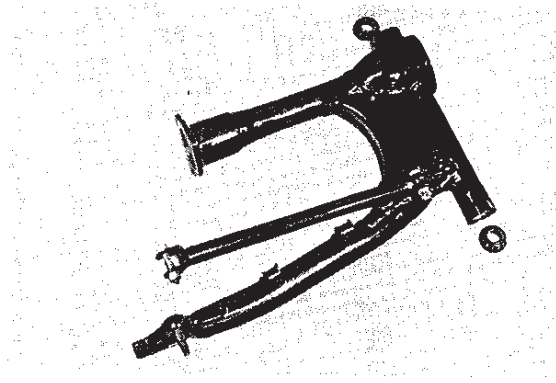

MOUNTING

- Install both inner roller bearings, to the rear swinging arm and install the rear swinging arm on the frame.
- Tighten both pivot shafts to specification.

Pivot shaft tightening torque	3.5 — 4.5 N·m 0.35 — 0.45 kg·m 2.5 — 3.0 lb·ft
-------------------------------	--

CAUTION:

The gaps between the frame and rear swinging arm should be even.

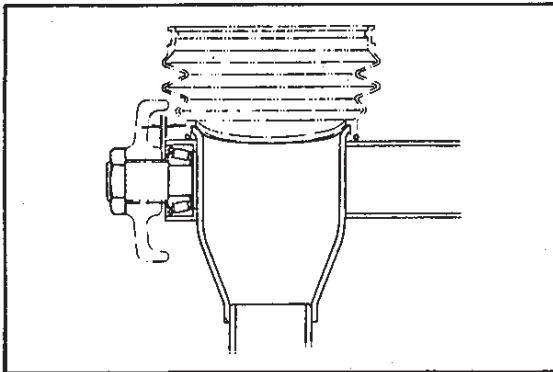

- Tighten both lock nuts to specification.

Nut tightening torque	110 — 130 N·m 11.0 — 13.0 kg·m 79.5 — 94.0 lb·ft
-----------------------	--

- Install the secondary boot.
- Install the final drive bevel gear assembly. (See page 75)
- Install the rear stop light switch.
- Mount the rear wheel.

DISASSEMBLY OF SWINGING ARM BEARING

- Using special tool ①, remove the bearing outer races, both right and left, from the swinging arm.

①	Bearing and oil seal remover	09941-64510
---	------------------------------	-------------

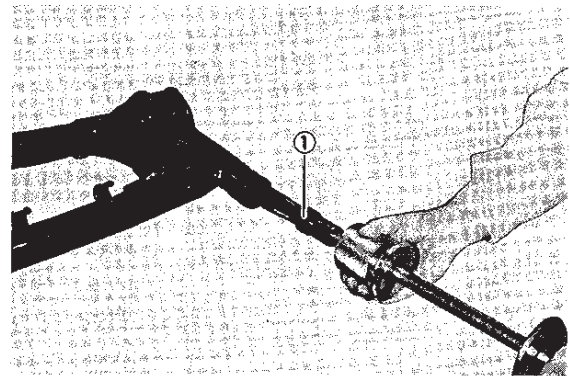

MOUNTING

- Using special tool ②, force-fit the bearing outer races, both right and left, into the swinging arm.

②	Bearing and oil seal handle	09924-74510
---	-----------------------------	-------------

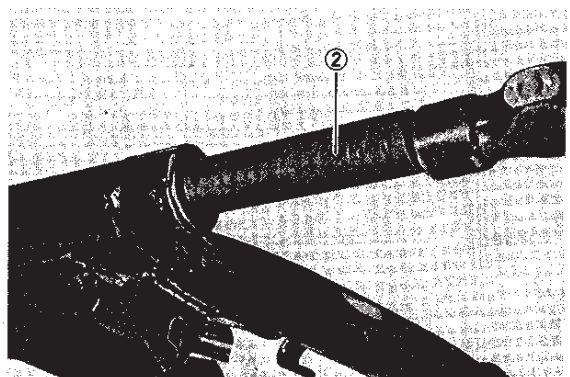

WIRE AND CABLE ROUTING

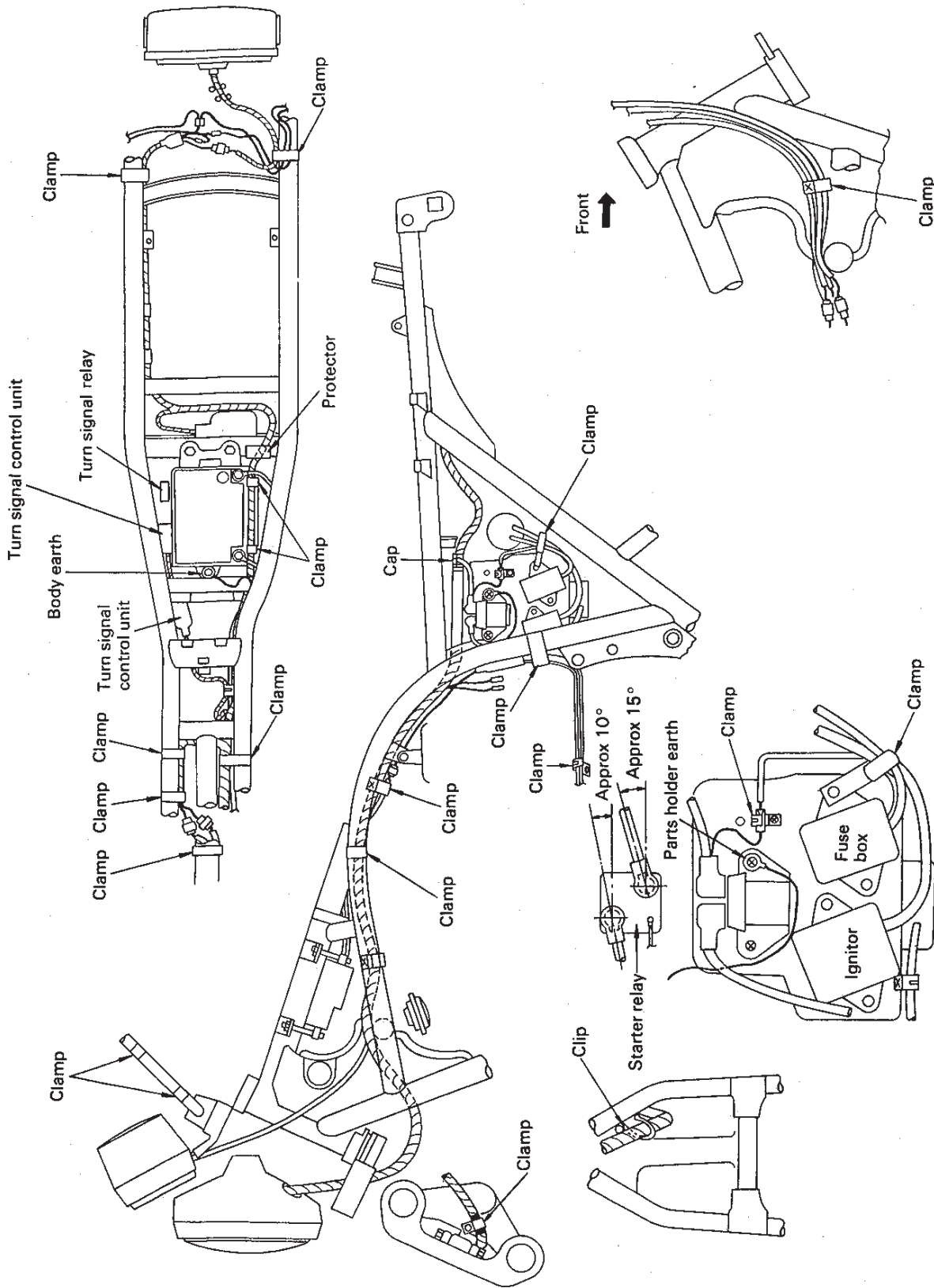

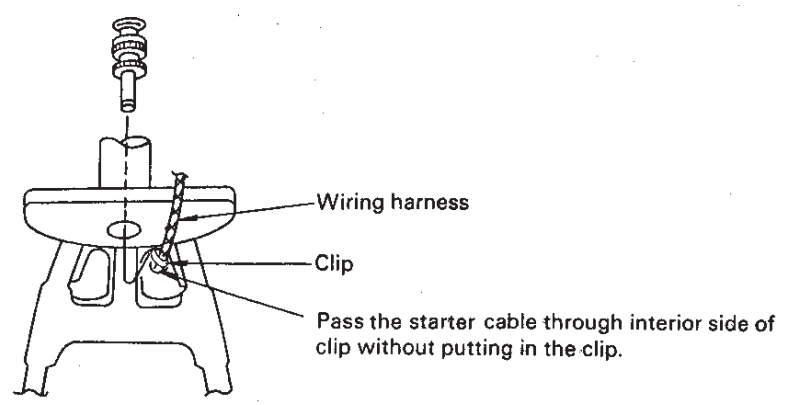
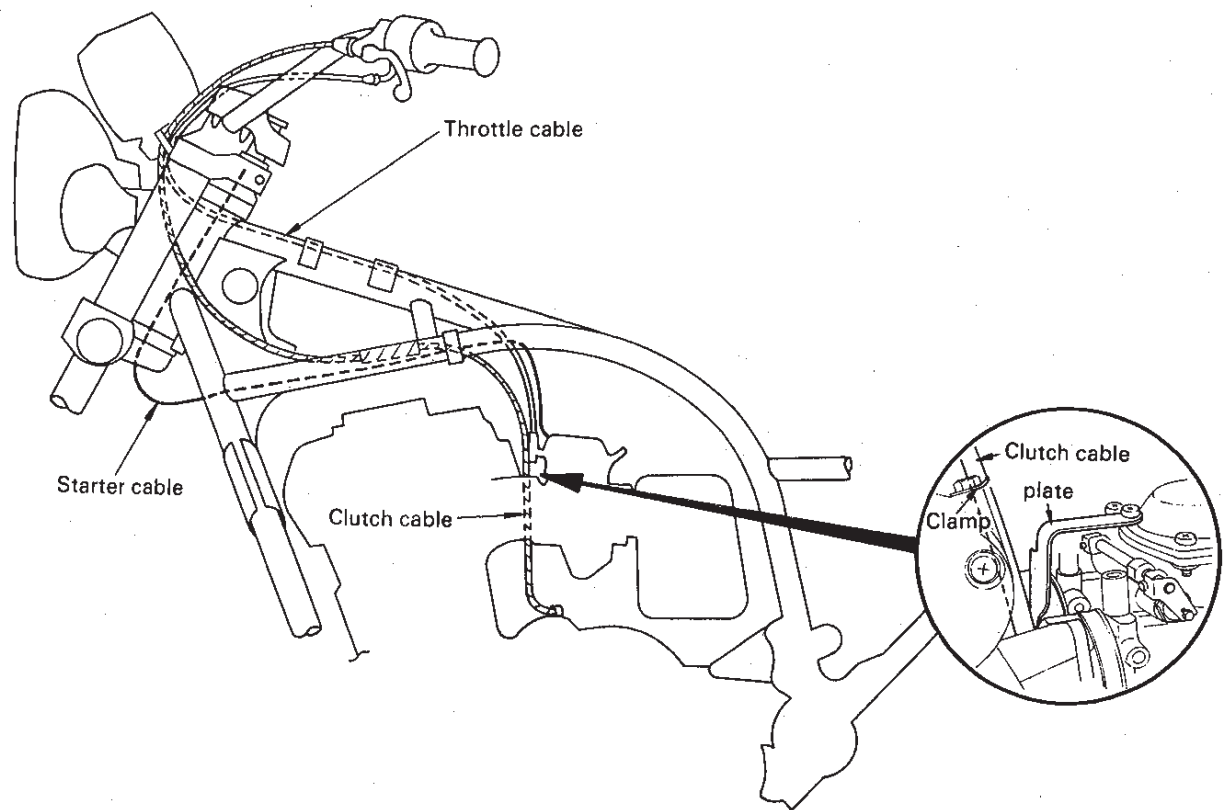
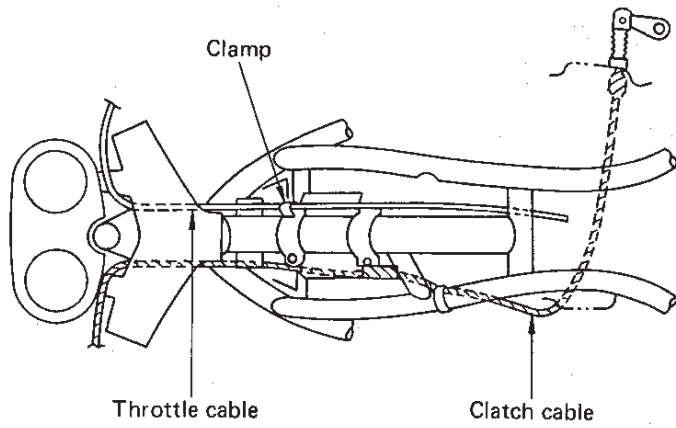

WIRING DIAGRAM

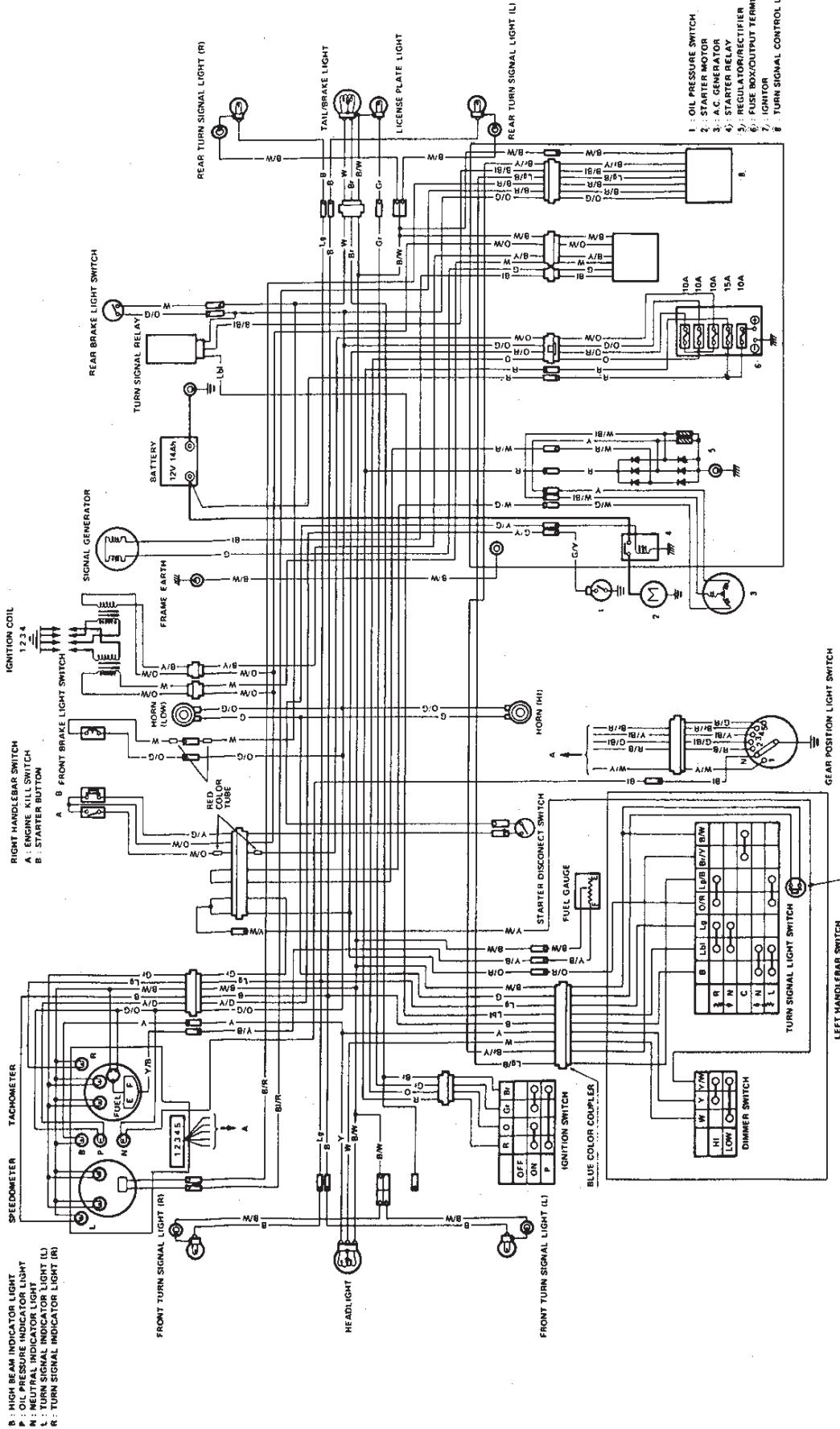

WIRE COLOR
 O Orange
 P Pink
 B Black
 Bl Blue
 Br Brown
 G Green
 Gr Gray
 Lbl Light blue
 Lg Light green

O Orange
 P Pink
 B Black
 Bl Blue
 Br Brown
 G Green
 Gr Gray
 Lbl Light blue
 Lg Light green

B/Y Black with Yellow tracer
 Bl/R Blue with Red tracer
 Bl/W Blue with White tracer
 Bl/Y Blue with Yellow tracer
 Br/R Brown with Red tracer
 Br/W Brown with White tracer
 Br/Y Brown with Yellow tracer
 G/B Green with Black tracer

G/Bl Green with Blue tracer
 G/R Green with Red tracer
 G/W Green with White tracer
 G/Y Green with Yellow tracer
 Gr/B Gray with Black tracer
 Lg/B Light green with Black tracer
 Lg/R Light green with Red tracer
 O/G Orange with Green tracer

O/R Orange with Red tracer
 O/W Orange with White tracer
 R/B Red with Black tracer
 R/G Red with Green tracer
 R/Y Red with Yellow tracer
 W/B White with Black tracer
 W/Bl White with Blue tracer

W/G White with Green tracer
 W/R White with Red tracer
 W/Y White with Yellow tracer
 Y/B Yellow with Black tracer
 Y/Bl Yellow with Blue tracer
 Y/G Yellow with Green tracer
 Y/R Yellow with Red tracer
 Y/W Yellow with White tracer

- 1 : OIL PRESSURE SWITCH
- 2 : STARTER MOTOR
- 3 : A.C. GENERATOR
- 4 : STARTER RELAY
- 5 : REGULATOR/RECTIFIER
- 6 : FUSE BOX/OUTPUT TERMINAL
- 7 : IGNITOR
- 8 : TURN SIGNAL CONTROL UNIT